

PROJECT MANUAL FOR:

**TP-2 Piping Connections and Insulation
Springfield Park District
Springfield, IL**

For:

**Springfield Park District
2500 South 11th Street
Springfield, IL 62703**

By:

**Jason Graham, Director of Parks and Planning
Springfield Park District
2500 S. 11th St.
Springfield, IL 62703**

**TP-2 Piping Connections and Insulation
Springfield Park District
Springfield, IL**

Table of Contents:

Advertisement for Bids

P.A. No. 100-1177

Ordinance # 1117-07

Ordinance # 1118-07

Ordinance # 1161-08

Instruction to Bidders

Summary of Quantities

Bid Form

Contractor Qualification Sheet

Bid Bond Form

Special Provisions

Acceptance or Non-Acceptance of Tenders

Contract

Notice to Proceed

Change Order

Appendix A: Contract Specifications

Appendix B: Contract Drawing Package

Appendix C: Project Schedules

Appendix D: Bidder Evaluation Criteria

ADVERTISEMENT FOR BIDS

Springfield Park District
2500 South 11th Street
Springfield, IL 62703

Will receive sealed bids for: TP-2 Piping Connections and Insulation

Contract Documents I.B. Storey US Inc., Joshua Ritchie
Prepared by: 17900 Gulf Blvd., Suite 3F
Redington Shores, FL 33708

PROJECT DESCRIPTION

This project consists of all required piping connections between equipment installed in the plant room and all insulation valves and components for fully functional process piping systems.

BIDDING REQUIREMENTS

All bidders are required to comply with the provisions of P.A. No. 100-1177, No. 1117-07 (Responsible Bidders Ordinance), No. 1118-07 (Project Labor Agreement) and No. 1161-08 (Substance Abuse Policy).

TIME AND PLACE OF BID SUBMITTAL

The Owner will receive sealed bids until 2:00 p.m. CT on 07-Jan-25, at which time the bids will be opened publicly. Bids are to be delivered to the Board Room in the Springfield Park District office, located in Bunn Park.

Bids should be directed to Mr. Jason Graham, Director of Parks & Planning
Springfield Park District
2500 South 11th Street
Springfield, IL 62703

Bids received after stated time will not be accepted and will be returned unopened.

TIME AND PLACE OF PRE-BID MEETING

Non-mandatory pre-bid meetings will be held on 06-Dec-24. The pre-bid meetings will be held at the Nelson Center Ice Rink located at 1601 N 5th St., Springfield, IL 62702 by appointment only. Contact bid@ibstorey.com to arrange an appointment.

CONTRACT DOCUMENTS

Until bids have been opened, plans and specifications shall be on file in the office of the Springfield Park District, 2500 South 11th Street, subject to the inspection of all parties desiring to bid. The Board of Trustees of the Springfield Park District reserves the right to waive any irregularities in the bids, reject any or all bids and to accept any bid deemed most advantageous to the district.

Obtain bidding documents at the office of the Springfield Park District located at 2500 South 11th Street (217-544-1751). A twenty-dollar (\$20.00) deposit is required. Checks shall be made payable to Springfield Park District. Electronic file available also.

BID STIPULATION

Bids shall be submitted in sealed envelopes marked "TP-2 Piping Connections and Insulation". An accompanying bid bond shall be equal to 10% of the total bid price. This may be in the form of a Certified Check, Bank Draft, or Bid Bond payable to the Owner.

Contractor shall not pay less than the prevailing rate of wages as determined by the Department of Labor to all laborers, workmen, mechanics performing work under this contract, and shall comply with the requirements of the Illinois Wages of Employees on Public Works Act.

The successful Bidder will be required to furnish a satisfactory Performance Bond and a Labor and Material Payment Bond for the full amount of the bid accepted.

Owner reserves the right to reject any or all proposals, to waive technicalities and minor irregularities in bidding, and to award a Contract for any part of the Work or the Project as a whole.

The Springfield Park District is an Equal Opportunity Employer. Minority business firms are encouraged to submit a bid for this project.

Bids shall include the following information which will be used to evaluate bidders as per Appendix D Bidder Evaluation Criteria:

1. A brief description of the company. Include a history of the company size, location, and areas of professional expertise. Specification of recommended installation, with detail that meets or exceeds the specifications outlined in the scope of work.
2. Stipulate that installation will occur as necessary to fulfill applicable codes and standards as they apply to refrigeration and mechanical systems.
3. A list of the key personnel who would be involved including any sub-consultants or sub-contractors.

4. Clearly outline demonstrated experience and understanding of process piping, mechanical concepts, including a summary of projects undertaken in the recreation sector, and a summary of projects involving process piping.
5. Only companies having successfully completed a minimum of 5 separate process piping system installations shall be qualified to bid this project. To establish competency and proof of ability the contractor shall submit a list of references including phone numbers and contacts.
6. Provide a proposed construction schedule for the installation of the glycol piping, water and relief piping systems. A schedule of any required demolition and erection of walls to enable equipment installation and relocation must be submitted for approval.
7. Proponent shall provide the total cost of the project. The proposed cost is to be turnkey. Taxes are to be added as a separate item.

MILESTONE DATES

Tender Posting	22-Nov-24
Non-Mandatory Pre-Bid Meeting	06-Dec-24
Deadline for Questions	31-Dec-24
Tender Closing	07-Jan-25
Substantial Completion	03-Oct-25

PREVAILING WAGE ACT

Any contract that calls for the construction of a “public work,” within the meaning of the Illinois Prevailing Wage Act, 820 ILCS 130/.01 *et seq.* (“the Act”). The Act required contractors and subcontractors to pay laborers, workers and mechanics performing services on public works projects no less than the “prevailing rate of wages” (hourly cash wages plus fringe benefits) in the county where the work is performed. For information regarding current prevailing wage rates, please refer to the Illinois Department of Labor’s website at: <http://www.state.il.us/agency/idol/rates/rates.HTM>. All contractors and subcontractors rendering services under such contract must comply with all requirements of the Act, including but not limited to, all wage, notice and record keeping duties.

ORDINANCE NO. 1404-17

**AN ORDINANCE OF THE SPRINGFIELD PARK DISTRICT
ADOPTING THE PREVAILING WAGE RATE**

WHEREAS, the State of Illinois has enacted "AN ACT regulating wages of laborers, mechanics and other workers employed in any public works by the State, County, City or any public body or any political subdivision or by any one under contract for public works," approved June 26, 1941, as amended, also known as the Prevailing Wage Act, (820 Illinois Compiled Statutes, Section 130/0.01 et. seq) and

WHEREAS, the aforesaid Act requires that the SPRINGFIELD PARK DISTRICT of the City of Springfield, Illinois, investigate and ascertain the prevailing rate of wages as defined in said Act for laborers, mechanics and other workers in the locality of Springfield, Illinois, employed in performing construction of public works, for said SPRINGFIELD PARK DISTRICT.

NOW THEREFORE, BE IT ORDAINED BY THE PRESIDENT AND BOARD OF TRUSTEES OF THE SPRINGFIELD PARK DISTRICT:

SECTION 1: To the extent and as required by "An Act regulating wages of laborers, mechanics and other workers employed in any public works by State, County, City or any public body or any political subdivision or by any one under contract for public works," approved June 26, 1941, as amended the general prevailing rate of wages in the locality for laborers, mechanics and other workers engaged in construction of public works coming under the jurisdiction work in the Sangamon County area as determined by the Department of Labor of the State of Illinois as of June of the current year a copy of that determination being attached hereto and incorporated herein by reference. As required by said Act, any and all revisions of the prevailing rate of wages by the Department of Labor of the State of Illinois shall supersede the Department's June determination and apply to any and all public works construction undertaken by the SPRINGFIELD PARK DISTRICT. The definition of any terms appearing in this Ordinance where are also used in aforesaid Act shall be the same as in said Act.

SECTION 2: Nothing herein contained shall be construed to apply said general prevailing rate of wages as herein ascertained to any work or employment except public works construction of the SPRINGFIELD PARK DISTRICT to the extent required by the aforesaid Act.

SECTION 3: The SPRINGFIELD PARK DISTRICT SECRETARY shall publicly post or keep available for inspection by any interested party in the main office of the SPRINGFIELD PARK DISTRICT this determination or any revisions of such prevailing rate of wage. A copy of this determination or of the current revised determination of prevailing rate of wages then in effect shall be attached to all contract specifications.

SECTION 4: The SPRINGFIELD PARK DISTRICT SECRETARY shall mail a copy of this determination to any employer, and to any association of employers and to any person or association of employers and to any person or association of employees who have filed their names and addresses, requesting copies of any determination stating the particular rates and the particular class of workers whose wages will be affected by such rates.

SECTION 5: The SPRINGFIELD PARK DISTRICT SECRETARY shall promptly file a certified copy of this Ordinance with both the Secretary of State Index Division and the Department of Labor of the State of Illinois.

SECTION 6: The SPRINGFIELD PARK DISTRICT SECRETARY shall cause to be published in a newspaper of general circulation within the area a copy of this Ordinance and such publication shall constitute notice that the determination is effective and that this is the determination of this public body.

PASSED: June 15, 2017

APPROVED: June 15, 2017

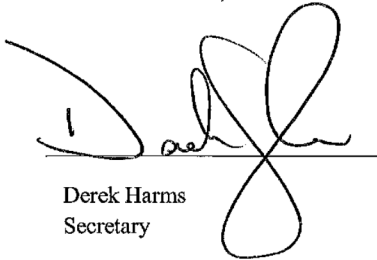

Derek Harms
Secretary

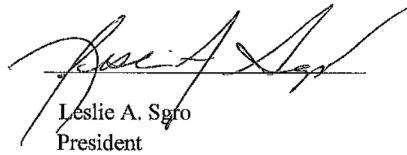

Leslie A. Sgro
President

ORDINANCE #1117-07
Responsible Bidders Ordinance

WHEREAS, the Springfield Park District, from time to time, prepares specifications, advertises, and awards bids, for the construction of various projects, or for the provision of services directly to the residents of the said Park District, and

WHEREAS, the Board of the said Park District desires to award the contracts for the construction of such projects, or for the provision of such services, to the lowest responsible bidder, in accord with the applicable Illinois law, and

WHEREAS, the said Board believes that it is the obligation of the Park District to comply with the various laws, both state and federal, which protect the health, safety, and welfare of the workers who are employed in the construction of its projects, or the provision of services to the residents of the District, and it is further the obligation of the Park District to encourage those to whom such construction or services contracts are awarded to comply with such statutes as well, and it is further the obligation of the Park District to encourage those to whom construction or service contracts are awarded to develop and maintain apprenticeship and training programs in order to provide a pool of qualified and skilled workers in the Springfield area, and

WHEREAS, the Board of the said Park District desires to adopt ordinances and follow practices and procedures designed to ensure, to the maximum extent possible, that it, and those with whom it contracts, do comply with the said state and federal statutes, and do provide apprenticeship and training programs,

NOW THEREFORE BE IT ORDAINED by the Board of the Springfield Park District as follows:

That from and after the passage and approval of this ordinance according to law, all specifications for the construction or substantial renovation of any building, roadway, bridge, shelter, parking lot, or other capital project, or for the provision of services directly to the residents of the said District, shall include a requirement that any person, firm, corporation, or other entity submitting a bid shall include a complete, accurate, and truthful listing and description of all citations, complaints, summons, decisions, determinations, judgments, or other allegations or findings of any violation of state or federal laws which protect the health, safety, or welfare of workers, including but not limited to, OSHA, FMLA, FLSA, ADA, ADEA, NLRA, the Federal Civil Rights Act, The Illinois Human Rights Act, the Illinois Wage and Hour Law, and the Prevailing Wage Act, filed against it or any entity with whom it is submitting the bid, including joint venturers and partners, and also including parent and subsidiary corporations or entities, and shall further include a statement that such bidder is a participant in at least one apprenticeship and training program approved by and registered with the United States Department of Labor's Bureau of Apprenticeship and Training, for the trades or crafts to be utilized on the project being bid, provided however, that the Board may waive the Apprentice and Training program requirement herein if no such program is available to the bidder. If the bidder has not been the recipient of any citations, complaints, summons, decisions, determinations, judgments, or other allegations or findings as aforesaid, it shall include a statement to that effect with its bid.

That any bidder who willfully fails or refuses to include the information required in Paragraph one, or whose report is substantially incomplete, inaccurate, or untruthful, shall be disqualified and its bid rejected.

That the Board may reject any bid and disqualify any bidder whose report, or subsequent inquiry into the matters contained in such report, reveals any of the following:

That there has been a finding, determination, or judgment by an agency of the state or federal government charged with the responsibility of enforcing laws and regulations which protect the health, safety, or welfare of workers, as enumerated above, or otherwise, that the bidder has violated such a statute or regulation, and that such violation was:

1. Found to have been part of a pattern of similar violations, or one of three or more similar violations committed within the two years immediately preceding the submission of the bid, or
2. Classified by an agency of the state or federal government as serious, or
3. One which threatened the health or safety of the workers employed by the bidder, or
4. One resulting in the payment of back wages and benefits of \$5,000 or more, or
5. One that resulted or could have resulted in the debarment of the bidder from contracting with the state or federal government, or any agency thereof.

That the bidder and its employees, do not actively participate in an apprenticeship and training program as aforesaid.

That any person, firm, corporation, or other entity seeking to submit bids for any project of, or for the provision of services to the residents of the said District as herein described, which has been disqualified or had its bids rejected by the Board on three or more occasions within the three years immediately preceding the submission of the bid which is then currently before the Board for consideration, shall be debarred from submitting further bids for such District projects for a period of one year following the rejection of the bid then currently being considered by the Board.

PASSED: September 18, 2007

APPROVED: September 18, 2007

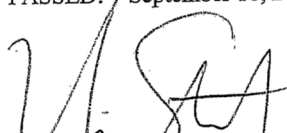

Michael Stratton, Secretary

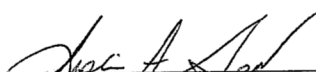

Leslie A. Sgro, President

ORDINANCE #1118-07
Project Labor Agreement (PLA)

WHEREAS, the Springfield Park District has a compelling interest in awarding public works contracts so as to ensure the highest standards of quality and efficiency at the lowest responsible cost; and

WHEREAS, a project labor agreement, which is a form of pre-hire collective bargaining agreement covering all terms and conditions of employment on a specific project, can ensure the highest standards of quality and efficiency at the lowest responsible cost on appropriate public works projects; and

WHEREAS, the Springfield Park District has a compelling interest that a highly skilled workforce be employed on public works projects to ensure lower costs over the lifetime of the completed project for repairs and maintenance; and

WHEREAS, project labor agreements provide the Springfield Park District with a guarantee that public works projects will be completed with highly skilled workers; and

WHEREAS, project labor agreements provide for peaceful, orderly, and mutually binding procedures for resolving labor issues without labor disruption; and

WHEREAS, project labor agreements allow public agencies to predict more accurately the actual cost of the public works project; and

WHEREAS, the use of project labor agreements can be of specific benefit to complex construction projects of large scope such as road construction and repair; and

WHEREAS, project labor agreements are useful from a cost, efficiency, quality, safety, and timeliness standpoint and in eliminating potential for friction by ensuring that work is performed by trade unions that have traditionally performed and have trade and geographic jurisdiction over the work performed; therefore

Be it Ordained by the Board of the Springfield Park District, as follows:

Section 1. Public Works Projects.

On a project-by-project basis, for those capital projects with an estimated cost in excess of thirty thousand dollars (\$30,000), the Springfield Park District shall include a project labor agreement requirement in the bid specifications unless it has been determined that a project labor agreement would not advance the District's interests of cost, efficiency, quality, safety, timeliness, skilled labor force, and labor stability and the District's policy to advance minority-owned and female-owned business.

Section 2. Negotiation of Project Labor Agreement.

Unless it has been determined that a project labor agreement is not appropriate for a particular public works project, the District shall either (i) in good faith negotiate a project labor agreement with labor organizations engaged in the construction industry that represent experienced and skilled construction workers or (ii) condition the award of a project manager or general contractor

upon a requirement that the manager or contractor negotiate in good faith a project labor agreement with labor organizations engaged in the construction industry and, if necessary, use the Department of Labor to reach a project labor agreement. The District may reserve the right to approve the negotiated project labor agreement.

Section 3. Contents of Project Labor Agreement.

A project labor agreement must:

1. Set forth effective, immediate, and mutually binding procedures for resolving jurisdictional disputes, labor disputes, and grievances arising before the completion of work;
2. Contain guarantees against strikes, lockouts, or other similar actions;
3. Standardize the terms and conditions of employment of labor on the public works project;
4. Permit flexibility in work scheduling and shift hours and times;
5. Ensure a reliable source of skilled and experienced labor;
6. Further public policy objectives as to improved employment opportunities for minorities, females, and the economically disadvantaged in the construction industry;
7. Permit contractors and subcontractors to retain a percentage of their current workforce in addition to labor referred through the signatory labor organizations;
8. Permit the selection of the lowest qualified responsible bidder, without regard to union or non-union status at other construction sites;
9. Be made binding on all contractors and subcontractors on the public works project through the inclusion of appropriate bid specifications in all relevant bid documents; and
10. Require all contractors and subcontractors on public works projects to sign the applicable master collective bargaining agreements with the labor organizations having jurisdiction over the type of work performed.

Section 4. Justification of Project Labor Agreement.

Any decision not to use a project labor agreement in connection with a public works project by the District shall be supported by a written, publicly disclosed finding by the District setting forth the justification for the non-use of the project labor agreement.

Section 5. Effective Date.

This Ordinance takes effect upon its passage by the Board of the Springfield Park District.

PASSED: September 18, 2007

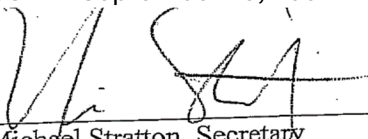

Michael Stratton, Secretary

APPROVED: Septmeber 18, 2007

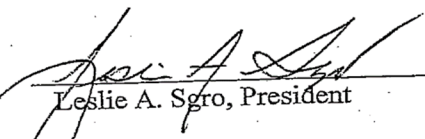

Leslie A. Sgro, President

BIDDING & CONTRACT REQUIREMENTS

Project Labor Agreement

SPRINGFIELD PARK DISTRICT

Standard Project Labor Agreement

Attached is the PROJECT LABOR AGREEMENT that the Contractor and Subcontractors will be required to sign

Project Labor Agreement

**SPRINGFIELD PARK DISTRICT
STANDARD PROJECT LABOR AGREEMENT**

This Agreement is entered into this ____ day of _____, _____, by and between the Springfield Park District (“District or Employer”) and the _____ **Project Labor Agreement Committee (PLA Committee)** for and on behalf of its affiliated members, individually and collectively. This agreement shall apply to work performed by the Employer and its Contractors and Subcontractors on construction projects known as the Springfield Park District Project No: _____ and described as:

ARTICLE I – INTENT AND PURPOSES

1.1 It is mutually understood that the following terms and conditions relating to employment of workmen covered by this Agreement have been written in order to promote efficiency of construction operations and provide for peaceful settlement of labor disputes without strikes or lockouts, thereby promoting the public interest in assuring the timely and economical completion of the work. It is also the intent of the parties to set out standard working conditions for the efficient prosecution of said construction work, herein to establish and maintain harmonious relations between all parties of the Agreement, to secure optimum productivity and to eliminate strikes, lockouts, or delays in the prosecution of the work.

(a) Therefore, the following provisions will be binding upon _____ Contractors and all its Subcontractors (hereinafter jointly referred to as “Contractor”), who shall be required to sign the “Participation Agreement”, attached hereto as “Schedule A”, and the Unions during the term of this Agreement and any renewal thereafter. The Unions hereby consent to apply the terms and conditions of the Project Labor Agreement to said Subcontractors upon their signing the “Participation Agreement”. It is understood that each Subcontractor will be considered and accepted by the Unions as a separate employer for the purposes of collective bargaining. It is further agreed that the employees working under this Agreement shall constitute a bargaining unit separate and distinct from all others. This Agreement may be modified by mutual consent in writing by the parties signatory hereto.

1.2 The Contractor agrees to be bound by the terms of the Collective Bargaining Agreements and amendments thereto of the affiliates of the PLA Committee and the applicable employers

association, if any. Such agreements are incorporated herein by reference. In order to comply with the requirements of the various fringe benefits funds to which the Contractor is to contribute, the Contractor shall sign such participation agreements as are necessary. Upon written notice from any fringe benefit fund the District will withhold payment of delinquencies occurring on this project from the involved Prime Contractors.

1.3 It is mutually understood that where the provisions of the Agreement are at variance with any other agreement between the Contractor and the Union, the language of this Agreement shall prevail.

1.4 The Contractor and the Union agree that should the Collective Bargaining Agreement (CBA) of any PLA Committee affiliates signatory to this Agreement expire prior to the completion of the project, the expired contract's terms will be maintained until a new CBA is ratified. The wages, and fringe benefits included in any new CBA will be effective on the effective date of the newly negotiated CBA unless wage and fringe benefit retroactivity is agreed upon by the bargaining parties.

ARTICLE II – RECOGNITION

2.1 The Contractor recognizes the PLA Committee and the signatory affiliates as the sole and exclusive bargaining representatives for its craft employees employed on the job site. PLA Committee affiliates signatory to the Agreement will have recognition on the project for their craft.

ARTICLE III – ADMINISTRATION OF AGREEMENT

3.1 In order to assure that all parties have a clear understanding of the Agreement, to promote harmony and address potential problems, a pre-job conference will be held with the Contractor, PLA Committee Representatives and all signatory parties prior to the start of any work on the project.

3.2 Representatives of the Contractor and the Unions shall meet as required but not less than once a month to review the operation of this Agreement. The representatives at this meeting shall be empowered to resolve any dispute over the intent and application of this Agreement.

3.3 The Contractor shall make available in writing to the Unions and Council no less than one week prior to these meetings a job status report, planned activities for the next 30 day period, actual members of craft employees on the project and estimated numbers of employees by craft required for the next 30 day period. The purpose of this report is to allow time to address any potential jurisdictional problems and to ensure that no party signatory to the Agreement is hindering the continuous progress of the project through a lack of planning or shortage of manpower.

ARTICLE IV – HOURS OF WORK, OVERTIME SHIFTS, & HOLIDAYS

4.1 The standard work day shall be an established consecutive eight (8) hour period between the hours of 7:00 a.m. and 5:00 p.m. with one-half hour designated as unpaid period for lunch. The standard work week shall be five (5) consecutive days of work commencing on Monday. Starting time which is to be established at the pre-job conference will be applicable to all craft employees on the project. Should job conditions dictate a change in the established starting time and/or a staggered lunch period on certain work of the project or with individual crafts, the Contractor, Business Managers of the crafts involved and the PLA Committee shall mutually agree to such changes. If work schedule change cannot be mutually agreed to between these parties, the hours fixed in the Agreement shall prevail.

4.2 All time before and after the established work day of eight (8) hours, Monday through Friday and all time on Saturday shall be paid in accordance with each crafts current collective bargaining agreement. All time on Sundays and Holidays shall be paid for at the rate of double time.

(a) Fringe benefit payments for all overtime work shall be paid in accordance with each craft's current collective bargaining agreement.

4.3 Shift work, if used, shall be as provided in the collective bargaining agreement of each affected craft.

4.4 Recognized Holidays shall be as follows: New Year's Day, Memorial Day, Fourth of July, Labor Day, Veterans Day (to be celebrated the day after Thanksgiving), Thanksgiving Day and Christmas Day. No work will be performed on Labor Day under any consideration, except in an extreme emergency and then only after consent is given by the Business Manager.

ARTICLE V – ABSENTEEISM

5.1 The Contractor and the Union agree that the chronic and/or unexcused absenteeism is undesirable and must be controlled. Employees that develop a record of such absenteeism shall be identified by the Contractor to the appropriate referral facility and the Contractor shall support such action with the work record of the involved employee. Any employee terminated for such absenteeism shall not be eligible for rehire on the project for a period of no less than ninety (90) days.

ARTICLE VI – MANAGEMENT RIGHTS

6.1 The Contractor retains and shall exercise full and exclusive authority and responsibility for the management of its operations, except as expressly limited by the terms of this Agreement and the Unions collective bargaining agreement.

ARTICLE VII – GENERAL WORKING CONDITIONS

7.1 Employment begins and ends at the project site, to be determined at the Pre-Job Conference.

7.2 Employees shall be at their place of work at the starting time and shall remain at their place of work until quitting time. The parties reaffirm their policy of a fair days work for a fair days pay.

7.3 The Contractor may utilize brassing, or other systems to check employees in and out. Should such procedures be required, the techniques and rules regarding such procedures shall be established by mutual consent of the parties at the pre-job conference.

7.4 There shall be no limit on production by workmen nor restrictions on the full use of tools or equipment. Craftsmen using tools shall perform any work of their trade and shall work under the direction of the craft foreman. There shall be no restrictions on efficient use of manpower other than as may be required by safety regulations.

7.5 Crew Foreman shall be utilized as per the existing collective bargaining agreements. The Contractor agrees to allow crew foremen ample time to direct and supervise the crew. The Union agrees there will be no restrictions placed on crew foreman's ability to handle tools and materials.

7.6 The Contractor may utilize the most efficient methods or techniques of construction, tools or other labor saving devices to accomplish the work. Practices not a part of the terms and conditions of this Agreement will not be recognized.

7.7 Should overtime work be required, the Contractor will have the right to assign specific employees and/or crews to perform such overtime work as is necessary to accomplish the work.

7.8 The Contractor may establish such reasonable project rules as the Contractor deems appropriate. These rules will be reviewed and established at the pre-job conference and posted at the project site by the Contractor.

7.9 It is recognized that specialized or unusual equipment may be installed on the project and in such cases, the Union recognizes the right of the Contractor to involve the equipment supplier or vendor's personnel in supervising the setting of the equipment, making modifications and final alignment which may be necessary prior to and during the start-up procedure, in order to protect factory warranties.

7.10 In order to promote a harmonious relationship between the equipment or vendor's personnel and the Building Trades craftsmen, a meeting shall be held between the Contractor and the Unions prior to any involvement on the project by these personnel. The Contractor will inform the Unions of the nature of involvement by these personnel and the numbers of personnel to be involved, allowing ample time for the Union representatives to inform their stewards prior to the start of any work.

ARTICLE VIII – SAFETY

8.1 The employees covered by the terms of this Agreement shall at all times while in the employ of the Contractor be bound by the safety rules and regulations by the Contractor in accordance with the Construction Safety Act and OSHA.

(a) These rules and regulations will be published and posted at conspicuous places throughout the project.

8.2 In accordance with the requirements of OSHA, it shall be the exclusive responsibility of each Contractor on a job site to which this Agreement applies, to assure safe working conditions for its employees and compliance by them with any safety rules contained herein or established by the Contractor. Nothing in this Agreement will make the District, PLA Committee or any of its affiliates liable to any employees or to other persons in the event that injury or accident occurs.

ARTICLE IX – SUBCONTRACTING

9.1 The Contractor agrees that neither he/she nor any of his subcontractors will subcontract any work to be done on the project except to a person, firm or corporation party signatory to this Agreement.

9.2 Any Contractor or Subcontractor working on the project covered by this Agreement shall as a condition to working on said project, become signatory to and perform all work under the terms of this Agreement. The furnishing of materials, supplies or equipment and the delivery thereof shall be considered subcontracting.

ARTICLE X – UNION REPRESENTATION

10.1 Authorized representatives of the PLA Committee and its signatory affiliates shall have access to the project provided they do not interfere with the work of the employees and further provided that such representatives fully comply with the visitor and security rules established for the project.

10.2 Each PLA Committee affiliate which is a party to this Agreement, shall have the right to designate a working journeyman as a steward. Such designated steward shall be a qualified worker performing the work of that craft and shall not exercise any supervisory functions. Each steward shall be concerned with the employees of the steward's employer and not with the employees of any other employer.

10.3 The working steward will be paid at the applicable wage rate for the job classification in which he/she is employed.

10.4 The working steward shall not be discriminated against because of his/her activities in performing his/her duties as steward, and except as otherwise provided in local agreements, shall

be the last employee in his/her craft to be laid off in any reduction in force. Stewards will be subject to discharge to the same extent that other employees are only after notification to the Union Representative. The Contractor will permit stewards sufficient time to perform the duties inherent to a steward's responsibilities. Stewards will be offered available overtime work if qualified.

ARTICLE XI – GRIEVANCE AND ARBITRATION PROCEDURES

11.1 It is specifically agreed that in the event any disputes arises out of the interpretation or application of the Agreement, excluding jurisdictional disputes which are covered by an expedited procedure in Article XII below, the same shall be settled by means of the procedure set out herein upon mutual agreement of the parties. Otherwise, the procedure set forth in the local collective bargaining agreement shall be used, but in no case shall both procedures be utilized to resolve such disputes. No such grievance shall be recognized unless called to the attention of the Contractor by the Union or to the Union by the Contractor within five (5) working days after the alleged violation was committed or discovered by the grieving party.

11.2 Grievances shall be settled according to the following procedure:

(a) Step 1. The dispute shall be referred to the Steward of the craft union involved and a representative of the Contractor at the construction project.

(b) Step 2. In the event that the steward and the Contractor's representative at the construction site cannot reach agreement within two (2) working days after a meeting is arranged and held, the matter shall be referred to the Union Business Manager, a representative of the PLA Committee and the Project Superintendent and/or Project Manager of the District.

(c) Step 3. In the event the dispute is not resolved within five (5) working days after completion of Step 2, these two shall request a panel of arbitrators from the U.S. Mediation and Conciliation Service for selection of an impartial arbitrator who shall hear the grievance and make a decision within ten (10) working days which shall be final and binding on all parties. The parties shall each pay the expense of their own representative. The decision of the arbitrator shall be binding upon all parties. The expense of the impartial arbitrator shall be borne equally by the Contractor and the involved craft Union.

ARTICLE XII – JURISDICTIONAL DISPUTES

This Agreement is entered into to prevent strikes, lost time, lockouts, and to facilitate the peaceful adjustment of jurisdictional disputes in the building and construction industry and to prevent waste and unnecessary avoidable delays and expense, and for the further purpose of at all times securing for the employer sufficient skilled workers.

12.1 All decisions of the Illinois Jurisdictional Dispute Resolution Process are final and binding upon all parties.

12.2 Administrative functions under the Illinois Jurisdictional Dispute Resolution Process shall be performed through the offices of the President and/or Secretary-Treasurer of the Illinois State Federation of Labor, or their designated representative.

12.3 The primary concern of the Illinois Jurisdictional Dispute Resolution Process shall be adjustment of jurisdictional disputes in the construction industry by independent Arbitrators selected by the Illinois State Federation of Labor. A sufficient number of Arbitrators shall be selected from geographical areas of the state of Illinois and shall be randomly assigned to a particular dispute subject only to the Arbitrator's ability to conduct a hearing and render a decision in a timely manner as required under this Process. Decisions shall be only for the specific job under consideration and shall become effective immediately upon issuance and complied with by all parties.

12.4 In rendering a decision, the Arbitrator shall determine:

(a) First, whether a previous agreement of record or applicable agreement, including a disclaimer agreement, between National or International Unions to the dispute or agreements between local unions involved in the dispute, governs;

(b) Only if the Arbitrator finds that the dispute is not covered by an appropriate or applicable agreement of record or agreement between the crafts to the dispute in the local area, the Arbitrator shall then consider whether there is a previous decision of record governing the case, including decisions of construction industry arbitration panels within the geographical jurisdiction of the local area Building Trades Council located within the State of Illinois;

(c) If the Arbitrator finds that a previous decision of record governs the case, the Arbitrator shall apply the decision of record in rendering his/her decision except under the following circumstances: After notice to the other parties to the dispute prior to the hearing that intends to challenge the decision of record, if a trade challenging the decision of record is able to demonstrate that the recognized and established prevailing practice in the locality of the work has been contrary to the applicable decision of record, and that historically in that locality the work in dispute has not been performed by the other craft or crafts, the Arbitrator may rely on such prevailing practice rather than the decision of record. If the craft relying on the decision of record demonstrates that it has performed the work in dispute in the locality of the job, then the Arbitrator shall apply the decision of record in rendering his/her decision. If the Arbitrator finds that a craft has improperly obtained the prevailing practice in the locality through raiding, the undercutting of wages, or the use of vertical

agreements, the Arbitrator shall rely on the decision of record than the prevailing practice in the locality;

(d) If no decision of record is applicable, the Arbitrator shall then consider the established trade practice in the industry and prevailing practice in the locality, and any party to the dispute may rely on prior decisions of record, decisions of construction industry arbitration panels within the state of Illinois.

(e) Only if none of the above criteria is found to exist, the Arbitrator shall then consider that because efficiency, cost or continuity and good management are essential to the well-being of the industry, the interests of the consumer or the past practices of the employer shall not be ignored.

12.5 The Arbitrator shall set forth the basis for his/her decision and shall explain his/her findings regarding the applicability of the above criteria. If lower ranked criteria are relied upon, the Arbitrator shall explain why the higher-ranked criteria were not deemed applicable. The Arbitrator's decision shall only apply to the job in dispute. Agreements of Record are applicable only to those parties signatory to such agreements. Decisions of Record are those that were either attested to by the former Impartial Jurisdictional Disputes Board or adopted by the National Arbitration Panel.

12.6 There shall be no abandonment of work during any case participating in the Process of in violation of the arbitration decision. All parties to the Process release the Illinois State Federation of Labor ("Federation") from any liability arising from its action or inaction and covenant not to sue the Federation.

12.7 In the event of a dispute relating to trade or work jurisdiction, all parties, including the employers, contractors or subcontractors, agree that a final and binding resolution of the dispute shall be resolved as follows:

(a) Representatives of the affected trades and the employer shall meet on the job site within forty-eight (48) hours after receiving notice in an effort to resolve the dispute. (In the event there is a dispute between local unions affiliated with the same International Union, the decision of the General President, or his/her designee, as the internal jurisdictional authority of the International Union, shall constitute a final and binding decision and determination as to the jurisdiction of the work.)

(b) If no settlement is achieved subsequent to the proceeding Paragraph, the matter shall be referred to the local area Building & Construction Trades Council, which shall meet with the affected trades within forty-eight (48) hours subsequent to receiving written notice. In the event the parties do not wish to avail themselves of the local Building & Construction Trades Council, the parties may elect

to invoke the services of their respective International Representatives with no extension of the time limitations. An agreement reached at this Step shall be final and binding upon all parties.

(c) If no settlement agreement is reached during the proceedings contemplated by Paragraphs “a” or “b” above, the matter shall be immediately referred to the Illinois Jurisdictional Dispute Board pursuant to the provisions of the Jurisdictional Dispute Resolution process, which may be amended from time to time, for final and binding resolution of said dispute. Said referral submission shall be in writing and served upon the Illinois State Federation of Labor, or its designated representative, pursuant to Article II of this agreement. The Administrator shall, within seventy-two (72) hours provide for the selection of an available Arbitrator to hear said dispute within this time period. Upon good cause shown to the Administrator, an additional seventy-two (72) hour extension for said hearing shall be granted at the sole discretion of the Administrator. Only upon mutual agreement of all parties may the Administrator extend the hearing for a period in excess of the time frames contemplated under this Paragraph. All time period contained in this Article specifically exclude Saturdays, Sundays and Holidays.

12.8 The Arbitrator chosen shall be randomly selected based on geographical location of the jurisdictional dispute and upon his/her availability to conduct a Hearing within forty-eight (48) hours of said notice. The Arbitrator may issue a “bench” decision immediately following the Hearing or he/she may elect to only issue a written decision, said decision must be issued within forty-eight (48) hours subsequent to the completion of the Hearing. Copies of all notices, pleadings, supporting memoranda, decisions, etc. shall be provided to all disputing parties, the local Building & Construction Trades Council, and the Illinois State Federation of Labor.

Any written decision shall be in accordance with this Process and shall be final and binding upon all parties to the dispute and may be a “short form” decision. Fees and costs of the Arbitrator shall be divided evenly between the contesting parties except that any party wishing a full opinion and decision beyond the short form decision shall bear the reasonable fees and costs of such full opinion.

In the event a jurisdictional dispute is not referred to the Illinois Jurisdictional Dispute Resolution Process by either (or any) of the labor organizations claiming the work, the employer may, upon its own initiative, or at the request of the Illinois Capital Development Board, petition the Administrator to assign an Arbitrator to hear the case. The decision of the Arbitrator shall be final and binding upon the parties hereto, their members, and affiliates.

In cases of jurisdictional disputes or other disputes between a signatory labor organization and another labor organization, both of which is an affiliate or member of the same International Union, the matter or dispute shall be settled in the manner set forth by their International Constitution and/or as determined by the International Union's General President whose decision shall be final and binding upon all parties. In no event shall there be an abandonment of work.

12.9 All interested parties shall be entitled to make presentations to the Arbitrator. Any interested party present at the Hearing, whether making a presentation or not, by such presence shall be deemed to accept the jurisdiction of the Arbitrator and to agree to be bound by its decision. In addition to the representative of the local labor organization, a representative of the local labor organization's International Union may appear on behalf of the parties. Each party is responsible for arranging for its witnesses. In the event an Arbitrator's subpoena is required, the party requiring said subpoena shall prepare the subpoena for the Arbitrator to execute. Service of the subpoena upon any witness shall be the responsibility of the issuing party.

Upon approval of the Arbitrator, other parties not directly involved in the dispute may be invited to be present during the presentation and discussion. Attorneys shall not be permitted to attend or participate in any portion of a Hearing.

The parties are encouraged to determine, prior to Hearing, documentary evidence which may be presented to the Arbitrator on a joint basis.

12.10 The Order of Presentation in all Hearings before an Arbitrator shall be:

- I. Identification and Stipulation of the Parties
- II. Union(s) claiming the disputed work presents its case
- III. Unions assigned the disputed work presents its case
- IV. Employer assigning the disputed work presents its case
- V. Evidence from other interested parties (i.e., general contractor, project manager, owner, etc.)
- VI. Rebuttal by union(s) claiming the disputed work
- VII. Additional submissions permitted and requested by Arbitrator
- VIII. Closing arguments by the parties

12.11 To further the interests of the Illinois Jurisdictional Dispute Resolution Process, it is agreed that any party hereto or any employer may at any time file a Verified Complaint in writing with the Administrator alleging a violation of a decision or award previously made by the Arbitrator. The Administrator shall thereupon set a subsequent Hearing, before the same Arbitrator who presided

at the initial Hearing or the next available Arbitrator in the event the original Arbitrator cannot timely hear the Verified Complaint. Said Hearing shall be held within three (3) days of receipt of the Verified Complaint with respect to the alleged violation. The Administrator shall notify all interested parties of the time and place of the Hearing; provided, however, that the party filing the Verified Complaint must have served a copy of said document and all supporting documents to all interested parties and the Administrator.

All parties shall be given an opportunity to testify and present documentary evidence relating to the subject matter of the Hearing. Within forty-eight (48) hours after the conclusion of the Verified Complaint, the Arbitrator shall render a written decision in the matter and shall state whether or not there has been a violation of the Arbitrator's prior decision or award. Copies of the decision shall be served by regular mail, personal service or facsimile.

Should the Arbitrator determine that there has been a violation of its prior decision or award, it shall order immediate compliance by the offending party(s). The Arbitrator may take one more of the following courses of action in order to enforce compliance with its decision:

(a) Assess liquidated damages not to exceed \$_____ for each violation by the members of, or employees represented by, the parties hereto, and may assess liquidated damages not to exceed \$_____ for each violation by either party hereto or any of its offices or representatives. If a fine is rendered by the Arbitrator, it should be commensurate with the seriousness of the violation having a relationship to lost hours for the labor organizations and lost efficiency for the employer. Each of the parties hereto hereby agrees for itself and its members to pay to the other party said liquidated damages within thirty (30) days from any sum, or sums, so assessed because of violations of a decision or award by itself, its officers or representatives, or its member(s). Should either party bound to this Process, or any of its members fail to pay the amount so assessed within the thirty (30) day time period herein provided, the party or member so failing to pay shall be deprived of all the benefits of this Process until such time as the matter is adjusted to the satisfaction of the Administrator; provided, however, the foregoing shall not prohibit the offending party from defending jurisdictional dispute claim in a subsequent, non-related matter.

(b) In the event the Arbitrator determines that there is a violation of this Section, the Arbitrator may order an immediate cessation of all work by the non-compliant employers and employees performing work on the project. Enforcement of any decision of an Arbitrator or finding of non-compliance, including remedies contemplated under this Section, shall be pursuant to the terms and conditions of Section 12.12.

The filing of a Verified Complaint is not a necessary requirement in order for a party to seek judicial enforcement of the Arbitrator's prior decision or award.

12.12 The Illinois Jurisdictional Dispute Resolution Process, as an arbitration panel, not its Administrator, shall have any authority to undertake any action to enforce its decision(s). Rather, it shall be the responsibility of the prevailing party to seek appropriate enforcement of a decision, including findings, orders or awards of the Arbitrator or Administrator determining non-compliance with a prior award or decision. The prevailing party in any enforcement proceedings shall be entitled to recover its costs and attorneys fees from the non-prevailing party. In the event the Illinois Jurisdictional Dispute Resolution Process or its Administrator is made a party to, or is otherwise required to participate in any such enforcement proceedings for whatsoever reason, the non-prevailing party shall bear all costs, attorneys' fees, and any other expenses incurred by the Process or the Administrator in those proceedings.

12.13 In the event there is a question as to the jurisdiction of the Illinois Jurisdictional Dispute Resolution Process, the primary responsibility for any determination of the arbitrability of a dispute and the jurisdiction of the Arbitrator shall be borne by the party requesting the Arbitrator to hear the underlying jurisdictional dispute. The affected party or parties may proceed before the Arbitrator even in the absence of one or more stipulated parties with the issue of jurisdiction as an additional item to be decided by the Arbitrator. The Administrator may participate in proceedings seeking a declaration or determination that the underlying dispute is subject to the jurisdiction and process of the Illinois Jurisdictional Dispute Resolution Process. In any such proceedings, the non-prevailing party and/or the party challenging the jurisdiction of the Illinois Jurisdictional Dispute Resolution Process shall bear all the costs, expenses and attorneys fees incurred by the Illinois Jurisdictional Dispute Resolution Process and/or its Administrator in establishing its jurisdiction.

12.14 All parties bound to the provisions of this Process hereby release the Illinois State Federation of Labor and the Illinois Capital Development Board, their respective officers, agents, employees or designated representatives, specifically including any Arbitrator participating in said Process, from any and all liability or claim, of whatsoever nature, and specifically incorporating the protections provided in the Illinois Arbitration Act, as amended from time to time.

ARTICLE XIII – WORK STOPPAGES AND LOCKOUTS

13.1 During the term of this Agreement there shall be no strikes, picketing, work stoppages, slow downs or other disruptive activity for any reason by the PLA Committee, its affiliates or by any

employee and there shall be no lockout by the Contractor. Failure of any Union or employee to cross any picket line established at the project site is a violation of this Article.

13.2 The PLA Committee and its affiliates shall not sanction, aid or abet, encourage or continue any work stoppage, picketing or other disruptive activity and will not make any attempt of any kind to dissuade others from making deliveries to or performing services for or otherwise doing business with the Contractor at the project site. Should any of these prohibited activities occur the Union will take necessary action to end such prohibited activities.

13.3 No employee shall engage in any activities which violate this Article. Any employee who participates in or encourages any activities which interfere with the normal operation of the project shall be subject to disciplinary action, including discharge, and if justifiably discharged for the above reasons, shall not be eligible for rehire on the same project for a period of not less than ninety (90) days.

13.4 Neither the PLA Committee or its affiliates, shall be liable for acts of employees for which it has not responsibility. The principal officer or officers of the PLA Committee will immediately instruct, order and use the best efforts of his/her office to cause the affiliated union or unions to cease any violations of this Article. The PLA Committee in its compliance with this obligation shall not be liable for unauthorized acts of its affiliates. The principal officer or officers of any involved affiliate will immediately instruct, order or use the best effort of his/her office to cause the employees the union represents to cease any violations of this Article. A union complying with this obligation shall not be liable for unauthorized acts of employees it represents. The failure of the Contractor to exercise its right in any instance shall not be deemed a waiver of its right in any other instance.

13.5 In lieu of any action at law or equity, any party shall institute the following procedure when a breach of this Article is alleged, after all involved parties have been notified of the fact.

(a) The party invoking this procedure shall notify an individual to be mutually agreed upon, whom the parties agree shall be the permanent Arbitrator under this procedure. In the event the permanent Arbitrator is unavailable at any time, he/she shall appoint his/her alternate. Notice to the Arbitrator shall be by the most expeditious means available, with notice by telegram or any effective written means to the party alleged to be in violation and all involved parties.

(b) Upon receipt of said notice the Arbitrator named above shall set and hold a hearing within twenty-four (24) hours it is contended the violation still exists but not before twenty-four (24) hours after the telegraph notice to all parties involved as required above.

(c) The Arbitrator shall notify the parties by telegram or any other effective written means, of the place and time he/she has chosen for this hearing. Said hearing shall be completed in one session. A failure of any party or parties to attend said hearing shall not delay the hearing of evidence or issuance of an Award by the Arbitrator.

(d) The sole issue at the hearing shall be whether or not a violation of this Article has in fact occurred. The Award shall be issued in writing within three (3) hours after the close of the hearing, and may be issued without an Opinion. If any party desires an Opinion, one shall be issued within fifteen (15) days, but its issuance shall not delay compliance with, or enforcement of, the Award. The Arbitrator may order cessation of the violation of this Article, and such Award shall be served on all parties by hand or registered mail upon issuance.

(e) Such Award may be enforced by any court of competent jurisdiction upon the filing of the Agreement and all other relevant documents referred to herein above in the following manner. Telegraphic notice of the filing of such enforcement proceedings shall be given to the other party. In the proceeding to obtain a temporary order enforcing the Arbitrator's Award as issued under Section 13.5 of this Article, all parties waive the right to a hearing and agree that such proceedings may be ex parte. Such agreement does not waive any party's right to participate in a hearing for a final order of enforcement. The Court's order or orders enforcing the Arbitrator's Award shall be served on all parties by hand or by delivery to their last known address or by registered mail.

(f) Any rights created by statute or law governing arbitration proceedings inconsistent with the above procedure or which interfere with compliance therewith are hereby waived by parties to whom they accrue.

(g) The fees and expenses of the Arbitrator shall be borne by the party or parties found in violation, or in the event no violation is found, such fees and expenses shall be borne by the moving party.

ARTICLE XIV – GENERAL SAVINGS CLAUSE

14.1 If any Article or provision of this Agreement shall be declared invalid, inoperative or unenforceable by operation of law or by any of the above mentioned tribunals of competent jurisdiction, the remainder of this Agreement or the application of this Article or provision to persons or circumstances other than those as to which it has been held invalid, inoperative or unenforceable shall not be affected thereby.

ARTICLE XV – TERM OF AGREEMENT

15.1 This Agreement shall be in full force as of and from the date of the Notice of Award to the Substantial Completion of all applicable contractors.

Executed this _____(day) of _____ (month), 20____ (yr), in the City of Springfield, Illinois.

The Springfield Park District

By: _____

Director of Parks and Planning

By the following signature the General Contractor, _____,

agrees to be bound to the attached Project Labor Agreement negotiated between the Springfield Park District and the PLA Committee.

By: _____

Its: _____

Project Labor Agreement Committee

Union: _____

By: _____

Title: _____

Date: _____

Union: _____

By: _____

Title: _____

Date: _____

Union: _____

By: _____

Title: _____

Date: _____

Union: _____

By: _____

Title: _____

Date: _____

Union: _____

By: _____

Title: _____

Date: _____

Union: _____

By: _____

Title: _____

Date: _____

Union: _____

By: _____

Title: _____

Date: _____

Union: _____

By: _____

Title: _____

Date: _____

Union: _____

By: _____

Title: _____

Date: _____

Union: _____

By: _____

Title: _____

Date: _____

SCHEDULE A
PARTICIPATION AGREEMENT

The undersigned, a Subcontractor to _____,

(General Contractor)

agrees to be bound to the attached Project Labor Agreement negotiated between the Springfield Park District and the Project Labor Agreement Committee.

(Subcontractor)

By: _____

Date: _____

(Subcontractor)

By: _____

Date: _____

(Subcontractor)

By: _____

Date: _____

(Subcontractor)

By: _____

Date: _____

(Subcontractor)

By: _____

Date: _____

(Subcontractor)

By: _____

Date: _____

Springfield Park District

ORDINANCE #1161-08

SUBSTANCE ABUSE PREVENTION IN PUBLIC WORKS PROJECTS

In order to comply with the terms of the Substance Abuse Prevention in Public Works Projects Act, Public Act 095-0635, the following ordinance is hereby adopted, effective immediately. To the extent that this ordinance is inconsistent with any other drug and alcohol ordinance of this employer dealing with contractors who contract with the Park District, this policy shall prevail, in so far as any work done or to be done on any public works project. To the extent that this policy is inconsistent with a collective bargaining agreement that this employer has with any labor organization that addresses the same subject matter, such labor agreement shall prevail in accordance with the Act.

Section 1. Definitions. As used in this Policy:

"Accident" means an incident caused, contributed to, or otherwise involving an employee that resulted in death, personal injury, or property damage and that occurred while the employee was performing work on a public works project.

"Alcohol" means any substance containing any form of alcohol including, but not limited to, ethanol, methanol, propanol, and isopropanol.

"Alcohol concentration" means: (1) the number of grams of alcohol per 210 liters of breath; or (2) the number of grams of alcohol per 100 milliliters of blood.

"Drug" means a controlled substance as defined in the Illinois Controlled Substances Act or cannabis as defined in the Cannabis Control Act for which testing is required by an employer under its substance abuse prevention program under this policy. The term "drug" includes prescribed medications not used in accordance with a valid prescription.

"Employee" means a laborer, mechanic, or other worker employed in any public works by anyone under a contract for public works.

"Employer" means a contractor or subcontractor performing a public works project.

"Public works" and "public body" have the meanings ascribed to those terms in the Prevailing Wage Act.

Section 2. Substance abuse prohibited. No employee may use, possess, distribute, deliver, or be under the influence of a drug, or use or be under the influence of alcohol, while performing work on a public works project for the Park District. An employee is considered to be under the influence of alcohol for purposes of this policy if the alcohol concentration in his or her blood or breath at the time alleged as shown by analysis of the employee's blood or breath is at or above 0.02.

Section 3. Substance abuse prevention programs required.

(1) Before an employer commences work on a public works project for the Park District, the employer shall have in place a written program which meets or exceeds the program requirements in this Act, to be filed with the District and made available to the general public, for the prevention of substance abuse among its employees. The testing must be performed by a laboratory that is certified for Federal Workplace Drug Testing Programs by the Substance Abuse and Mental Health Service Administration of the U.S. Department of Health and Human Services. At a minimum, the program shall include all of the following:

(A) A minimum requirement of a 9 panel urine drug test plus a test for alcohol. Testing an employee's blood may only be used for post-accident testing, however, blood testing is not mandatory for the employer where a urine test is sufficient.

(B) A prohibition against the actions or conditions specified in Section 2.

(C) A requirement that employees performing the work on a public works project submit to pre-hire, random, reasonable suspicion, and post-accident drug and alcohol testing. Testing of an employee before commencing work on a public works project is not required if the employee has been participating in a random testing program during the 90 days preceding the date on which the employee commenced work on the public works project.

(D) A procedure for notifying an employee who violates Section 2, who tests positive for the presence of a drug in his or her system, or who refuses to submit to drug or alcohol testing as required under the program that the employee may not perform work on a public works project until the employee meets the conditions specified in subdivisions (2)(A) and (2)(B) of Section 3.

(2) Reasonable suspicion testing. An employee whose supervisor has reasonable suspicion to believe the employee is under the influence of alcohol or a drug is subject to discipline up to and including suspension, and be required to undergo an alcohol or drug test. "Reasonable suspicion" means a belief, based on behavioral observations or other evidence, sufficient to lead a prudent or reasonable person to suspect an employee is under the influence and exhibits slurred speech, erratic behavior, decreased motor skills, or other such traits. Circumstances, both physical and psychological, shall be given consideration. Whenever possible before an employee is required to submit to testing based on reasonable suspicion, the employee shall be observed by more than one supervisory or managerial employee. It is encouraged that observation of an employee should be performed by a supervisory or managerial employee who has successfully completed a certified training program to recognize drug and alcohol abuse. The employer who is requiring an employee to be tested based upon reasonable suspicion shall provide transportation for the employee to the testing facility and may send a representative to accompany the employee to the testing facility. Under no circumstances may an employee thought to be under the influence of alcohol or a drug be allowed to operate a vehicle or other equipment for any purpose. The employee shall be removed from the job site and placed on inactive status pending the employer's receipt of notice of the test results. The employee shall have the right to request a representative or designee to be present at the time he or she is directed to provide a specimen for testing based upon reasonable suspicion. If the test result is positive for drugs or alcohol, the employee shall be subject to termination. The employer shall pay all costs related to this testing. If the test result is negative, the employee shall be placed on active status and shall be put back to work by

the employer. The employee shall be paid for all lost time to include all time needed to complete the drug or alcohol test and any and all overtime according to the employee's contract.

(3) An employer is responsible for the cost of developing, implementing, and enforcing its substance abuse prevention program, including the cost of drug and alcohol testing of its employees under the program, except when these costs are covered under provisions in a collective bargaining agreement. The testing must be performed by a laboratory that is certified for Federal Workplace Drug Testing Programs by the Substance Abuse and Mental Health Service Administration of the U.S. Department of Health and Human Services. The contracting agency is not responsible for that cost, for the cost of any medical review of a test result, or for any rehabilitation provided to an employee.

Section 4. Employee access to project.

(1) An employer may not permit an employee who violates Section 2, who tests positive for the presence of a drug in his or her system, or who refuses to submit to drug or alcohol testing as required under the employer's substance abuse prevention program under Section 3 to perform work on a public works project for the District until the employee meets the conditions specified in subdivisions (2)(A) and (2)(B). An employer shall immediately remove an employee from work on a public works project if any of the following occurs:

(A) The employee violates Section 2, tests positive for the presence of a drug in his or her system, or refuses to submit to drug or alcohol testing as required under the employer's substance abuse prevention program.

(B) An officer or employee of the Park District, preferably one trained to recognize drug and alcohol abuse, has a reasonable suspicion that the employee is in violation of Section 2 and requests the employer to immediately remove the employee from work on the public works project for reasonable suspicion testing.

(2) An employee who is barred or removed from work on a public works project under subsection (1) may commence or return to work on the public works project upon his or her employer providing to the contracting agency documentation showing all of the following:

(A) That the employee has tested negative for the presence of drugs in his or her system and is not under the influence of alcohol as described in Section 2.

(B) That the employee has been approved to commence or return to work on the public works project in accordance with the employer's substance abuse prevention program.

(C) Testing for the presence of drugs or alcohol in an employee's system and the handling of test specimens was conducted in accordance with guidelines for laboratory testing procedures and chain-of-custody procedures established by the Substance Abuse and Mental Health Service Administration of the U.S. Department of Health and Human Services.

(3) Upon successfully completing a rehabilitation program, an employee shall be reinstated to his or her former employment status if work for which he or she is qualified exists.

Section 5. Applicability. This Act applies to a contract to perform work on a public works project for which bids are opened on or after January 1, 2008, or, if bids are not solicited for the contract, to a contract to perform such

work entered into on or after January 1, 2008. The provisions of this Act apply only to the extent there is no collective bargaining agreement in effect dealing with the subject matter of this Act.

Section 6. The Park District reserves the right to reject any bid for any public works project of the District submitted by any contractor that does not have the policies and programs required by the Act and this ordinance, or a collective bargaining agreement covering the same subject matter, in effect at the time of the submission of its bid for the public works project, or at the time work on the project is to be commenced. If, at the time a public works project of the District is to be commenced, the contractor does not have the policies and programs in place as required by the Act and this ordinance, the Park District may elect to terminate the contract with such contractor.

Section 7. Effective date. This Act takes effect from and after its passage according to law.

Passed: February 20, 2008

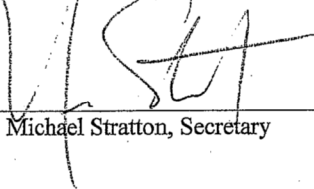

Michael Stratton, Secretary

Approved: February 20, 2008

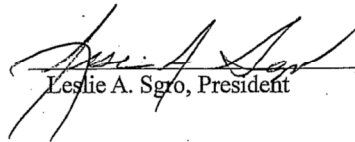

Leslie A. Sgro, President

INSTRUCTIONS TO BIDDERS

EXAMINATION OF SITE

Bidder shall examine the site and all conditions thereon. Proposal shall consider all conditions that may affect contract work. No additional expenses will be allowed for failure to be so informed.

DISCREPANCIES

Should bidder find during examination of specifications or drawings or after visit to site, discrepancies, omissions, ambiguities, or conflicts about Contract documents. Or being in doubt as to their meaning, he/she should notify the Consultant or the Springfield Park District not later than three (3) days prior to the due date of the bid. If required, an addendum will be issued to all prospective bidders a minimum of one (1) day before bid opening.

WITHDRAWAL OF BIDS

Bids may be withdrawn at any time prior to scheduled time for opening of the bids. NO BIDDER may withdraw his/her bid for a period of thirty (30) days after the bid date.

BID REQUIREMENTS

A detailed Bid Proposal has been provided. Bids will be received for the total cost of the contract. The total cost of the contract shall be obtained by taking the product of the quantity for a bid item multiplied by the unit price per item and then adding the resultant products. The Contractor shall furnish all equipment, tools, labor, materials, and incidentals and shall include the cost of these items in the unit price for the work. The quantities appearing in the bid proposal are estimates prepared for the establishment of pay item prices and the comparison of bids. Payment to the Contractor will be made on a unit basis in accordance with this bid proposal for the actual measured quantities performed and accepted or material furnished and accepted or material furnished and accepted according to the contract, and the scheduled quantities may be increased, decreased, or omitted as herein provided.

Contractor must qualify as to his/her competency in the trade he/she is bidding prior to receiving a set of contract documents. He/She must be willing to cooperate with the Owner if asked for additional information to determine his/her qualifications.

Contractor, after award of work, shall provide a performance bond in the amount of one hundred percent (100%) of the amount of his/her bid awarded.

TIME OF COMPLETION

All work shall be completed 38 weeks from the start date of an executed Notice to Proceed. Failure to complete this work by these dates will result in liquidated damages as provided within this document.

REJECTION OF BIDS

The owner, Springfield Park District, reserves the right to reject any or all bids and to waive any technicalities in the bids.

No bid may be withdrawn for a period of thirty (30) days after the opening of bids without the consent of the District. The failure to submit a cashier's check, certified check or bid bond in the full amount to cover the proposals being bid upon shall be enough cause for rejection of the bid.

BID FORM

Proposal must be made on the bid form provided and delivered to the address stated in the advertisement for bids before 2:00 p.m. CT on 07-Jan-24 at which time bids will be opened publicly.

Oral, telephone or telegraphic proposals will not be considered.

PRE-BID MEETINGS

Non-mandatory pre-bid meetings will be held on 06-Dec-24. The pre-bid meetings will be held at the Nelson Center Ice Rink located at 1601 N 5th St., Springfield, IL 62702 by appointment only. Contact bid@ibstorey.com to arrange an appointment.

TP-2 Piping Connections and Insulation
Springfield Park District
Summary of Quantities

Description	Amount
Misc. Mechanical Equipment	
Cold Glycol Piping System	
Warm Glycol Piping System	
Domestic Water and Relief Piping Systems	
Installation of Automation Supplied Control Valves and Instrumentation	
Construction Total	

Submitted By: _____
Contractor

Authorized Signature

BID FORM

BID TO: SPRINGFIELD PARK DISTRICT
BID FROM: _____
(BIDDER'S NAME)

(BIDDER'S ADDRESS)

A. THE UNDERSIGNED

1. Acknowledges receipt of:

A. Project Manual for: TP-2 PIPING CONNECTIONS AND INSULATION
SPRINGFIELD PARK DISTRICT
SPRINGFIELD, IL

b. Drawings: Included in the Project Manual

c. Addenda: No. _____ Dated _____
No. _____ Dated _____
No. _____ Dated _____
No. _____ Dated _____

2. Has examined the sites and all Bidding Documents. He/She shall be responsible for performing all work specifically required of him/her by all parts of the Bidding Documents, including all Drawings and Specifications for the entire projects even though such work may be included as related requirements specified in other divisions or sections.

3. Agrees to:

a. Hold this Bid open until 30 calendar days after Bid Opening Date.

b. Accept the provision regarding disposition of bid security.

c. Enter into and execute a Contract with The Springfield Park District, when awarded on the basis of this Bid, and in connection therewith to:

- i. Furnish all bonds and insurance in accord with the Bidding Documents
- ii. Accomplish the work in accord with the Contract
- iii. Complete the work by the specified completion date

B. CONTRACT TIME SPECIAL NOTE – DEADLINE FOR COMPLETION

Contractor shall commence work upon receipt of an executed “Start After” date and shall complete all work 38 weeks from the start date of an executed Notice to Proceed.

C. THE UNDERSIGNED PROPOSES and AGREES AS FOLLOWS:

ITEM Proposed **BASE BID** contract amount:

The undersigned PROPOSES to furnish all labor, materials, and equipment required in connection with the construction of the above referenced project, in accordance with the Project Manual, Specifications, Drawings and any Addenda as hereinafter listed, for the TOTAL COST OF THE CONTRACT OF \$ _____. Total Cost of the Contract shall be the sum of the resultant products obtained by multiplying the quantity of a bid item by the respective unit bid price provided on the Summary of Quantities. Payment will be based on actual quantities performed at the unit price on the Bid Proposal.

1. Completion:

The undersigned AGREES to complete all required work of the contract as stated in Time of Completion.

2. Bidding Documents:

This proposal is in all respects based upon the following documents, all as issued for bidding purposes by The Springfield Park District,

a. Specifications:

Project Manual

Specifications included in the Project Manual and outlined by the document:
“24-009 SPD TP-2 Piping Connections & Insulation Specification v1.0”

b. Drawings Included in the Project Manual and outlined as:

“24-009 PKG02 – TP2 Piping Connections & Insulation Drawings v1.0”

If bidder is:
AN INDIVIDUAL

BY _____ (Seal)
(Individual's Name)

Doing Business as _____ (Seal)
Business Address _____
Phone Number _____

A PARTNERSHIP

BY _____ (Seal)
(Firm Name)

(General Partner)

Business Address _____
Phone Number _____

A CORPORATION

BY _____ (Seal)
(Corporation Name)

(State of Incorporation)

BY _____
(Name and Title of Person Authorized to Sign)

(Corporate Seal)

Attest _____

A JOINT VENTURE

BY _____
(Name)

Business Address _____

BY _____
(Name of Person Authorized to sign)

TP-2 PIPING CONNECTIONS AND INSULATION
SPRINGFIELD PARK DISTRICT
2500 South 11th Street, Springfield IL 62703

OTHER CONDITIONS, PROVISIONS OF REQUESTED INFORMATION

**CONTRACTOR QUALIFICATIONS
PREVIOUS SIMILAR PROJECTS**

Please provide a list of some projects successfully completed by your firm in the last five years. Include in this information the Owner's name, address, phone number and contact person.

Project Name	Contact	Phone #	Completion Date
_____	_____	_____	_____
_____	_____	_____	_____
_____	_____	_____	_____

PREVAILING WAGE SCHEDULE

Pursuant to P.A. 100-1177: Attached is the current Schedule of Prevailing Wage Rates.

<https://labor.illinois.gov/laws-rules/conmed/current-prevailing-rates.html>

“PUBLIC CONTRACT CERTIFICATION: The undersigned Contractor does hereby certify that the Contractor is not barred from contracting with any unit of state or local government as a result of violation of either Section 5/33 E-3 (Bid-rigging) or Section 5/33 E-4 (Bid-rotating) of the Illinois Criminal Code of 1961, as amended (720 ILCS 5/33 E-3 and 720 ILCS 5/33 E-4). This certification is made pursuant to section 5/33 E-11 of the Illinois Criminal Code of 1961, as amended (720 ILCS 5/33 E-11).

Date _____ Signed _____

Firm/Title _____

BID BOND

KNOW ALL MEN BY THESE PRESENTS, that we the undersigned, _____
as
PRINCIPAL, AND _____, as SURETY are held and firmly bound unto
the Springfield Park District, hereinafter called the Grantee/Local Public Agency in the
penal sum of _____ Dollars, (\$_____), lawful money in the United States, for the
payment of which sum well and truly to be made, we bind ourselves, our heirs, executors,
administrators, successors, and assigns, jointly and severally, firmly by these presents.

THE CONDITION OF THIS OBLIGATION IS SUCH, that Whereas the Principal has
submitted the Accompanying Bid, dated _____, _____ yr, for
TP-2 Piping Connections and Insulation.

NOW, THEREFORE, if the Principal shall not withdraw said Bid within the period specified
therein after opening the same, or, if no period be specified, within thirty (30) days after the
said opening, and shall within the period specified therefore, or if no period specified,
within ten (10) days after the prescribed forms are presented to him for signature, enter
into a written Contract with the Grantee/Local Public Agency in accordance with the Bid as
accepted, and give bond with good and sufficient surety or sureties, as may be required,
for the faithful performance and proper fulfillment of such contract; or in the event of the
withdrawal of said Bid within the period specified, or the failure to enter into such Contract
and give such bond within the time specified, if the Principal shall pay the Grantee/Local
Public Agency the difference between the amount specified in said Bid and the amount for
which the Grantee/Local Public Agency may procure the required work or supplies or both,
if the latter be in excess of the former, then the above obligation shall be void and of no
effect, otherwise to remain in full force and virtue.

IN WITNESS WHEREOF, the above-bounded parties have executed this instrument under
their several seals this _____ day of _____, _____yr, the name and corporate
seal of each corporate party being hereto affixed and these present signed by its
undersigned representative, pursuant to authority of its governing body.

1. Forms of Bid Bonds prepared to meet the requirements of local or State laws or the
needs of the Grantee/Local Public Agency should be substituted for this form where
necessary.

_____ (SEAL)

_____ (SEAL)

Attest:

By: _____

Attest:

By: _____

By: _____

Countersigned by _____

2. Attorney-in-Fact, State of _____

CERTIFICATE AS TO CORPORATE PRINCIPAL

I, _____, certify that I am the _____,
_____, Secretary of the Corporation named as the Principal in the
within bond; that _____, who signed the bond on behalf of the Principal was
then _____, of said corporation; that I know his signature, and
his signature thereto is genuine; and that said bond was duly signed, sealed, and attested
to for and in behalf of said corporation by authority of this governing body.

Title _____

Power-of-attorney for person signing for surety company must be attached to bond.

SPECIAL PROVISIONS

PRE-CONSTRUCTION MEETING

The Contractor shall schedule a meeting with the Springfield Park District prior to beginning any work. The purpose of this meeting is to discuss the project schedule and any other items which may be necessary. The Springfield Park District should be notified at least 24 hours prior to any construction operations taking place.

CONTRACTOR'S RESPONSIBILITY FOR SAFETY

The Contractor shall do all work necessary for safety and be solely and completely responsible for conditions on the jobsite, including safety of all persons and property during the contract period. This requirement shall apply continuously and not be limited to normal working hours.

PROTECTION OF PUBLIC PROPERTY

The Contractor shall employ such means and methods as necessary to adequately protect public property of the Owner against damage. In the event of damage to such property, the Contractor shall, at his own expense, immediately restore the property to a condition equal to its original condition and to the satisfaction of the Consultant and the owner of said property.

RESTORATION OF EXISTING FACILITIES AND CLEANUP

Any item, such as sidewalks, mailboxes, gate posts and gates, signs, fences, shrubbery, etc., not shown to be removed on the Plans, which is damaged by the Contractor, shall be replaced at his/her own expense.

The cost of cleanup operations shall be included in the Contractor's bid. Cleanup shall consist of removing all debris from the job site, to include removal of all excess concrete, pipe pieces, lumber scraps, paper cups, etc., left by the Contractor. Initial cleanup shall be performed before moving forces to the next portion of the job, and a final cleanup will be done after all operations have been completed.

BID GUARANTEE

A cashier's check or Bid bond, payable to Springfield Park District (Owner) in an amount equal to ten percent (10%) of the Contractor's total bid price as a proposal guarantee, shall accompany each bid.

PERFORMANCE BOND & PAYMENT BOND

A performance and payment bond for one hundred percent (100%) of the awarded contract price shall be presented to the Springfield Park District prior to construction.

PREQUALIFICATION OF BIDDER

Prior to receiving a proposal for bidding, the interested bidder shall submit to the Owner a list of similar projects for which he/she had total responsibility for the construction thereof. Owner shall consider, but not be limited to, the following items: Integrity, professional abilities, workmanship, the present condition of previously constructed facilities, usage and care of facility and such other investigations as it may deem necessary to satisfy itself of the bidder's ability to perform under contract. The prequalification of the bidder shall not prejudice the Owner's right to accept or reject any of all bids.

INSURANCE

Procurement of the insurance by the Contractor shall be considered solely for the Contractor's obligation or liabilities under the Contract Documents. The Contractor shall remain fully liable and responsible for all such obligations, whether or not the insurance provided by him/her is approved by the Owner and whether or not such insurance is sufficient in amount, quality, or coverage, to protect him/her against liability, and shall pay and make good all such obligations to the full extent such insurance does not cover them.

If the Contractor fails to obtain and continue to maintain any insurance required by the Contract Documents, the Owner may obtain such as the cost of the Contractor, which cost shall be deducted from any sums due to Contractor under the Contract Documents.

The required minimum coverage, unless higher limits are required by law, are as follows:

1. Employer's Liability – Illinois Statutory Limit \$500,000 min.
2. Public Liability and Property Damage (insuring Owner and Contractor)
 - a. Comprehensive General Liability
 - 1.) \$1,000,000 Bodily Injury per person
 - 2.) \$1,000,000 Bodily Injury per occurrence
 - 3.) \$1,000,000 Property Damage each occurrence
(Completed Operations Board Form)
 - 4.) \$2,000,000 Property Damage Aggregate
 - b. Comprehensive Automobile Liability (Owner, Non-owned and Hired)
 - 1.) \$1,000,000 Bodily Injury per person
 - 2.) \$1,000,000 Bodily Injury per occurrence
 - 3.) \$1,000,000 Property Damage per occurrence
3. All Insurance policies shall cover direct operations, sublet work and contractual liability on the part of the Contractor and shall have "XCU" Coverage (i.e., the removal of exclusions for explosions, collapse and underground property damage).

Contractor shall require subcontractors not protected under his insurance to take out and maintain workmen's compensation insurance and insurance of the same kind in amounts specified above. Contractor shall submit evidence of coverage of insurance required.

SCHEDULES

The Contractor shall, at all times, keep the Project Consultant or Springfield Park District informed of the progress of the work, methods, and proposed schedules and sequences.

WORK

"Work" includes all materials, labor and use of tools, equipment and services and all other items necessary to complete construction in full compliance with the terms of the contract.

BID ACCEPTANCE

The Springfield Park District reserves the right to accept, or reject, any or all proposals, and to waive any technicalities in any or all proposals.

All specifications, drawings, and this Project Manual shall become part of the Contract.

COMPLIANCE WITH STATE LAWS

Each bidder shall thoroughly acquaint him/her with all provisions of the State of Illinois laws pertaining to labor and working conditions on public projects and, by submitting a proposal for this work, acknowledges that he/she is cognizant of such laws and affirms that if awarded a contract, he/she will comply with all the provisions of such statutes which specifically include, but are not limited to, the following:

1. An Act to give preference in construction of public work projects and improvements to citizens of the United States who have resided in Illinois for one (1) year.
2. An Act to prohibit discrimination and intimidation on account of race or color in employment under contracts for public buildings or public works. All contracts for work or for services of any kind shall incorporate the following cause: "In any work or services performed discrimination because of race, color, creed or national origin is prohibited."
3. Contractor shall be prequalified with Illinois Fair Employment Practices Commission and shall list such prequalification number on the appropriate space shown on the proposal.

PERMITS, BUILDING LAWS AND ORDINANCES

The Contractor shall obtain and pay for all permits and inspector's fees required without extra cost to the Owner.

PAYMENT

The Contractor shall submit with his/her application for payment a "Contractor's Affidavit", duly witnessed, that he/she has duly discharged his/her obligations and that no liens are against the amount requested. Contractor shall also furnish "Waiver of Lien" from subcontractor and material suppliers, requiring payment for the materials involved in the amount being requested. After payment of the work, the Board shall be obliged to no individual or supplier of material for any contractor's unpaid bills.

METHOD OF PAYMENT

Payment for work performed under this contract is to be made in cash or check from funds provided by the Owner for the purpose of financing this project. Partial payments shall be made no later than the tenth (10th) day of the month next following the application for payment by the Contractor. Final payment shall be made within thirty (30) days after completion and acceptance of the complete project. Partial payment shall be for 90% of the value of work completed with 10% being retained by owner until the project is 100% completed.

SUBCONTRACTORS

The Contractor, upon request, shall submit a list of subcontractors to the Owner. These must be acceptable to the Owner prior to commencing work. The Contractor shall be fully responsible to the Owner for acts and omissions of his/her subcontractors. Nothing contained in the Contract documents shall create any contractual relations between any subcontractor and the Owner or representative thereof.

OWNERS RIGHT TO TERMINATE CONTRACT

If the Contractor should be adjudged bankrupt, or if he/she should make a general assignment for the benefit of this creditors, or if a receiver should be appointed on account of his/her insolvency, or if he/she should persistently or repeatedly refuse or should fail, except in cases for which extension of time is provided, to supply enough skilled workmen, or proper material, or persistently disregard laws, ordinances, or the instruction to the Owner, and/or it's representative or otherwise be guilty of a substantial provision of the contract, then the Owner may without prejudice to any other right or remedy and after giving the contractor seven (7) days written notice, terminate the employment of the Contractor and take possession of the premises and all material, tools and appliances thereon and finish the work by whatever means may be expedient. In such case, the Contractor shall not be entitled to receive any further payment until work is finished. If the expense of finishing the work shall not exceed the unpaid balance, such excess shall be paid to the Contractor. If such expense, however, shall exceed the amount of the unpaid balance, the Contractor shall pay the difference to the Owner.

OMISSIONS

The drawings and specifications are intended to cooperate. Anything shown on the drawings but not mentioned in the specifications or vice-versa, or anything not expressly set forth in either, but which is reasonably implied shall be furnished as though specifically shown and mentioned in both, without any extra charge. Should anything be omitted from the drawings necessary to the proper construction of the work herein described, it shall be the duty of the Contractor to so notify the Consultant or the Springfield Park District before signing this Contract, and in the event of the Contractor failing to give such notice, he/she shall make good any damage or defects in his/her work caused without extra charge.

CHANGES IN WORK

Minor modifications in drawings and specifications may be made by the Owner to effect an improvement in the completed work where such modification is accepted with the understanding that it makes no change in the contract price or time, and it is with prejudice to any and all rights of the Owner under the Contract and Bond.

Where an adjustment in contract price or time is involved, the requirements of the Contractor shall not be changed or modified except by supplemental written agreement of a "change order". The "change order" shall describe the change, fix the sum thereof, and/or the modifications of the contract time involved.

No charge for any extra work or material will be allowed unless the same has been ordered by the Owner or its representative.

INTERPRETATION

All questions or disagreements between the Owner and the Contractor relating to the interpretation of the drawings and specifications, or kind and quality of material and workmanship required thereby shall be referred to the Consultant or the Springfield Park District. Consultant or Springfield Park District decisions shall be final, conclusive, and without equal.

DETAIL AND WORKING DRAWINGS

Additional detail and working drawings will be furnished in amplification of the contract drawings as they may be required. All such additional drawings as they are furnished are to be considered of equal force with those which accompany these specifications. A complete set of drawings and specifications must be kept at the work site.

MATERIALS

Unless otherwise specified all materials shall be new and of quality equal to the manufacturer's representatives of the product specified. Where no material is specified by name of type, its quality shall conform to the Standards of the ASTM. Each Contractor shall, if required, furnish satisfactory evidence as to the kind and quality of his/her materials. All materials in or designed for the work shall always be properly housed or protected, particular care being taken of all finished parts.

LIMITS OF OPERATION

The Contractor shall confine his/her apparatus, the storage of material and the operation of his/her workmen to the limits directed by the representative of the Owner.

GUARANTEE

If, within one (1) year after the acceptance of the Work or within such longer period of time as may be prescribed by law or by the terms of any applicable special guarantee, any of the Work is found to be defective, the Contractor shall correct promptly after receipt of a written notice from the Owner.

UTILITY LOCATIONS

The location, size and type of material of existing underground utilities indicated on the plans are not represented as being accurate, sufficient or complete. It shall be the Contractor's responsibility to determine the actual location of all such facilities.

CONTRACTOR'S RESPONSIBILITY FOR SAFETY

The Contractor shall do all work necessary for safety and be solely and completely responsible for conditions on the jobsite, including safety of all persons and property during the contract period. This requirement shall apply continuously and not be limited to normal working hours.

SUBSURFACE CONDITIONS

The Contractor shall assume the risk of meeting quicksand, hardpan, boulder clay, rubbish, buried railroad ties and all other unforeseen obstacles. No claim for any amount of money beyond the contract price of the work will be entertained or allowed because of the nature of the ground in which excavation is made. Bidders shall make such borings as they deem necessary to determine the subsurface conditions that may be encountered.

EARTHWORK

The Contractor shall remove and dispose of all unsuitable material off-site as required for construction of the project according to the plans. This work shall be considered to the contract.

SUBGRADE APPROVAL

NA

TRAFFIC CONTROL

YES

AUTHORITY OF THE CONSULTANT

The Consultant or his designate shall represent the Owner in all matters relating to the Construction of the Project. All correspondence, changes, additions, deletions, or corrections regarding these project documents shall be directed to the Consultant.

The Consultant shall have the authority to stop the work when it may be necessary to insure the proper execution of the contract. He/She shall have the authority to order the removal of any work completed which does not comply with the plans of the modifications.

The Consultant shall decide all questions which may arise relative to performance of the contract and his/her decision shall be final and binding.

The Contractor shall preserve all lines and grades and inform the Consultant at least 48 hours in advance of needing additional field staking.

The Contractor shall always have on the job a competent superintendent who shall have authority to act in his behalf of any orders received from the Consultant. The Contractor shall name in writing one general superintendent who has authority to provide direction to and coordinate for all the various trades and crews utilized throughout the construction of this work.

Any Contractor desiring to work any hours other than the regular working hours shall inform the Consultant in advance. No additional compensation will be allowed for overtime work.

If there is no Contracted Consultant for this project, this authority is given to the Springfield Park District staff.

ACCEPTANCE OR NON-ACCEPTANCE OF BIDS

Contractors are advised that Springfield Park District reserves the right to accept any bid or reject all. Bids shall be irrevocable and remain open for acceptance by Springfield Park District for a period of ninety (90) days from the tender closing date. **The Springfield Park District shall accept the lowest responsible bid, if any.**

Springfield Park District may refuse to consider a bid should any of the following conditions exist:

- * A bid is not submitted as required (e.g. bid submitted after the due time and date, required information not provided, etc.)
- * All addenda are not acknowledged in the Submission.
- * Any other defect which, in the opinion of Springfield Park District brings the validity of the tender into question

In order to obtain the most advantageous offer for Springfield Park District, it reserves the right in its sole discretion:

- * To waive irregularities and/or minor non-compliance by any Contractor with the requirements of this Tender,
- * To request clarification and/or further information from one or more Contractor after closing without obligation to offer the same opportunity to all Contractors,
- * To enter into negotiations with one or more Contractors without obligation to negotiate with, or, offer the same opportunity to, all Contractors,
- * If negotiations with a Successful Contractor do not result in a Contract Agreement, to enter into negotiations with any other Contractor regardless of such Contractor's evaluation score, or to discontinue negotiations and terminate this Tender, at its option.

Contractors are advised however to submit a complete offer as their tender. Any waiver, clarification or negotiation will not be considered as an opportunity for Contractors to correct errors in their tender.

It is understood and accepted by the Contractor that all decisions on whether a bid satisfies the Mandatory Requirements and meets, or to what degree it meets, the stated evaluation criteria are the judgment of Springfield Park District in its sole discretion.

Springfield Park District is not obligated to award any contract as a result of this Tender and reserves the right in its sole discretion to cancel this Tender process at any time before or after closing without providing reasons for such cancellation.

Springfield Park District reserves the right to negotiate provisions in addition to those stipulated in this Tender or proposed by the Successful Contractor.

TP-2 CONTRACT

1. THIS AGREEMENT, made and concluded this ____ day of _____, 20____, between Springfield Park District known as the party of the first part, and _____ (Contractor) his/their executors, administrators, successors or assigns, known as the party of the second part.
2. WITNESSETH: That for and in consideration of the payments and agreements mentioned in the Project Manual hereto attached, to be made and performed by the party of the first part, and according to the terms expressed in the Bond referring to these present, the party of the second part agrees with said party of the first part at his/their own proper cost and expense to do all the WORK, furnish all materials and all labor necessary to complete the WORK in accordance with the Plans and Specifications hereinafter described and in full compliance with all of the plans of this agreement and the requirements of the Consultant and/or Springfield Park District under it.
3. And it is also understood and agreed that the Project Bid Package and Contract Bond hereto attached, and the Plans for TP-2 Piping Connections and Insulation, are all essential documents of this Contract and are a part hereof.
4. II WITNESS WHEREOF, the said parties have executed these presents on the date above mentioned.

For the OWNER
Party of the First Part

Signature: _____

By: Derek Harms

Title: Executive Director

For the CONTRACTOR
Party of the Second Part

Signature: _____
(President, Party of the Second Part)

By: _____

Attest:

(Clerk or Notary Public)

Title: _____

(Corporate Seal)

(If a Co-Partnership) _____(SEAL)
_____(SEAL)
_____(SEAL)

TP-2 NOTICE TO PROCEED

To: _____ Date: _____

Project: _____

You are hereby notified to commence **WORK** in accordance with the Agreement dated

_____, 20____, on or after January 17th, 2025.

By: _____

Title: _____

Acceptance of Notice

Receipt of the above NOTICE TO PROCEED is hereby

Acknowledged by _____

Title: _____

This the _____ day of _____, 20_____.

Please return an **original signed** copy of this document to the:

Springfield Park District

ATTN: _____

2500 South 11th Street

Springfield, IL 62703

CHANGE ORDER

Order No. _____

Date: _____

Agreement Date: _____

NAME OF PROJECT: _____

OWNER: _____

CONTRACTOR: _____

JUSTIFICATION: _____

Change to CONTRACT PRICE: \$ _____

Original CONTRACT PRICE: \$ _____

Current CONTRACT PRICE adjusted by previous CHANGE ORDER \$ _____

The CONTRACT PRICE due to this CHANGE ORDER will be (increased) (decreased) by:

The new CONTRACT PRICE including this CHANGE ORDER will be \$ _____

Change to CONTRACT TIME: _____

The CONTRACT TIME will be (increased) (decreased) by _____ calendar days.

The date for completion of all work will be _____ (Date)

Requested by: _____

Recommended by: _____

Accepted by: _____

Appendix A

Contract Specifications

PART 1 – GENERAL

1.1 Scope of Work

- .1 The objectives of this project encompass the following:
 - .1 Provide the required process piping, insulation, valving and piping equipment for fully functional glycol systems at the Nelson Center located at 1601 North 5th St, Springfield, Illinois 62703.
 - .2 Execute work using the most effective use of time and resources.
 - .3 Minimize disruption of arena operation, and co-ordinate any required service disruption with the Owner and the Consultant.
 - .4 Work may commence, at the earliest, by 17-Jan-25.
 - .5 All work is to be substantially completed by 12-Sep-25
 - .6 Work is to be completed as per Appendix C: Project Schedules as it relates to TP-2
 - .1 Construction schedule milestones include the following:
 - .1 Plant Room Access for Piping install – 22-Jul-25
 - .2 Process Piping Installed – 18-Aug-25
 - .3 Rink #2 Tie-in 12-Sep-25
 - .4 Rink #1 Tie-in 12-Sep-25

1.2 Definitions

- .1 Piping Connections and Insulation: This replacement consists of all required piping connections between equipment installed in the plant room and all insulation valves and components for fully functional process piping systems.
- .2 Contractor: The single Contractor to provide the work of this Bid Document. This Contractor shall be the supplier, installer, and commissioner. This party shall be the contractor signatory to the contract, and shall take on all responsibilities therein. The Contractor shall supply all materials, labor, and equipment required to complete all work and provide all fully functional deliverables.
- .3 The Owner: For the specifications herein the Springfield Park District shall be referred to as The Owner.
- .4 The Consultant: For the specifications herein I.B. Storey US Inc shall be referred to as the Consultant.

1.3 Description

- .1 Supply and install piping components, including valves, piping, insulation, and labor.
- .2 Install all automated valves, instrumentation and wells supplied by Automation Contractor
- .3 The work shall consist of the provision of all labor, materials, tools, equipment, testing, commissioning, training services, transportation, shipping, handling, administration, supervision, management, insurance, temporary protection, cleaning, removal, installation, cutting and patching, warranties, services, and items, even though these may not be specifically mentioned in this documents which are required for the complete, fully functional and commissioned system.
- .4 Provide a complete, neat and workmanlike installation. Use only employees who are certified journeyman or registered apprentices (under the supervision of a journeyman). The labor used to carry out the work shall be skilled, experienced, trained, and familiar with the specific equipment, software, standards and configurations to be provided for this Project. Contractors must submit registration numbers for key personnel that are certified journeyman.
- .5 Manage and coordinate the work in a timely manner in consideration of the Project schedule.

1.4 Drawings Package

- .1 Drawings packages have been issued with this specifications document and are referred to as 24-009 PKG02 – TP2 Piping Connections & Insulation Drawings
- .2 In the event of discrepancy between the drawings package and this specifications document, the specifications document shall prevail unless otherwise noted. Any discrepancies should be brought to the Owner's attention prior to proceeding.

1.5 Quality Assurance

- .1 General
 - .1 The Contractor shall be regularly engaged in the installation and service of process piping systems.
 - .2 The system components included in this project shall consist of the products from manufacturers regularly engaged in the production of refrigeration and mechanical equipment, and shall be the manufacturer's latest standard of design at the time of bid.
- .2 Workplace Safety and Hazardous Materials
 - .1 Provide a safety program in compliance with the Contract Documents.

- .2 Contractor shall have a corporately certified comprehensive Safety Manual and a designated Safety Supervisor for the Project.
 - .3 The Contractor and its employees and subtrades comply with local, state, and federal safety regulations.
 - .4 The Contractor shall ensure that all subcontractors and employees have written safety programs in place that covers their scope of work, and that their employees receive the training required by the Occupational Safety and Health Administration for the State of Illinois for at least each topic listed.
 - .5 Hazards created by the Contractor or its subcontractors shall be eliminated before any further work proceeds.
 - .6 Hazards observed but not created by the Contractor or its subcontractors shall be reported to the Consultant and the Owner within the same day. The Contractor shall be required to avoid the hazard area until the hazard has been eliminated.
 - .7 The Contractor shall sign and date a safety certification form prior to any work being performed, stating that the Contractors' company is in full compliance with the Project safety requirements.
 - .8 The Contractor's safety program shall include written policy and arrangements for the handling, storage and management of all hazardous materials to be used in the work in compliance with the requirements of the Authorities Having Jurisdiction at the Project site.
 - .9 The Contractor's employees and subcontractor's staff shall have received training as applicable in the use of hazardous materials and shall govern their actions accordingly.
- .3 Quality Management Program
- .1 Designate a competent and experienced employee to provide Project Management. The designated Project Manager shall be empowered to make technical, scheduling and related decisions on behalf of the Contractor. At minimum, the Project Manager shall:
 - .1 Manage the scheduling of the work to ensure that adequate materials, labor and other resources are available as needed
 - .2 Manage the financial aspects of the Contract, with respect to the budget and payment applications.
 - .1 Be responsible for the work and actions of the workforce on site

1.6 References

- .1 The Contractor shall fully comply with all codes and standards applicable to this type of work, including;
 - .1 State Occupational Safety and Health Administration (OSHA)
 - .2 The National Electrical Code
 - .3 National Fire Code
 - .4 ASME Boiler and Pressure Vessel Code (BPVC)
 - .5 Underwriters Laboratories (UL) listing and labels
 - .6 American National Standards Institute (ANSI)
 - .7 American Society for Testing and Materials (ASTM)
 - .8 American Society of Heating, Refrigeration and Air-Conditioning Engineers (ASHRAE) Standards:
 - .1 ASHRAE Standard 15 - Safety Standard for Refrigeration System
 - .2 ASHRAE Standard 34 – Designation and Safety Classification of Refrigerants.
- .2 In the case of conflicts or discrepancies, the more stringent regulation shall apply
- .3 All work shall meet the approval of the Authorities Having Jurisdiction at the project site

1.7 Shop Drawings

- .1 Manufacturer’s data sheets must be used for each product included as part of the scope of work. The submittal package must include:
 - .1 Install preparation instructions, methods, and recommendations.
 - .2 Safety requirements and details.
 - .3 Operating and design parameters such as temperatures, pressures, RPM, and physical size.
 - .4 Performance and equipment specifications.
 - .5 Storage and handling requirements and recommendations.
- .2 All specifications for equivalents being offered must be received electronically by the Consultant for review no later than the question deadline during the bidding process.
 - .1 For maintenance purposes, equivalents for equipment will only be approved if all equipment of a similar type meet the specifications (such as pumps).
- .3 Shop drawings must also contain complete wiring and schematic diagrams, sequences of operation, control system bus layouts, and any other details required to demonstrate that the system has been coordinated and will properly function as a system.

1.8 Record
Documentation

- .1 Provide two (2) paper copies and one (1) USB digital copy of operating and maintenance manuals for all installed equipment pertaining to this contract, including as-built drawings
- .2 After completion of all tests and adjustments, the contractor shall provide a copy of all as-built information and product data.
- .3 On Site documents: Maintain at job site, one copy each of the following (but is not limited to):
 - .1 Contract drawings.
 - .2 Specifications.
 - .3 Addenda.
 - .4 Reviewed shop drawings.
 - .5 List of outstanding shop drawings.
 - .6 Change orders.
 - .7 Other modifications to Contract.
 - .8 Copy of approved Work schedule.
 - .9 Health and Safety Plan and other Safety related documents.
 - .10 Manufacturers' installation and application instructions.
 - .11 Labor conditions and wage schedules.
 - .12 Other documents as specified.
- .4 Manual shall be bound in three (3) ring binders and contain, as a minimum, the following:
 - .1 System operation and maintenance instructions, troubleshooting guidelines and operating log.
 - .2 Safety bulletins and material safety data sheets.
 - .3 Reviewed and approved (stamped) shop drawings
 - .4 Completed and approved Application for water connection form (As Required). Contractor to comply with all local and state backflow prevention requirements, where applicable
 - .5 Approvals by all Authorities having jurisdiction.
 - .6 Equipment operation and maintenance instructions
- .5 As-built drawings must contain, as a minimum, the following;
 - .1 All flow schematics and as installed piping
- .6 Prepare an index of all submittals and shop drawings for the installation. Index shall include a shop drawing identification number, Contract Documents reference and item description.
- .7 The contractor shall correct any errors or omissions noted in the first review.
- .8 Within two (2) weeks of contract award the contractor shall provide a schedule, in a Gantt Chart to the Owner and the Consultant, which summarizes all construction timelines and milestone dates. Including, but not limited to:

- .1 Shop drawing submittal and review time;
- .2 Equipment order dates;
- .3 Lead time;
- .4 Site construction milestones
- .5 On-site completion;
- .6 Substantial completion;
- .7 Owner turnover.

1.9 Warranty

- .1 Standard Material and Labor Warranty:
 - .1 Provide a one-year labor and material warranty on the piping, insulation and equipment components following substantial completion.
 - .2 If within twelve (12) months from the date of acceptance of a product, upon written notice from the Owner, it is found to be defective in operation, workmanship, or materials, it shall be replaced, repaired, or adjusted at the option of the Contractor at the cost of the Contractor.

PART 2 – Details

2.1 Scope of Work

- .1 Supply and install one (1) Cold Loop Air Separator (AS-1)
 - .1 Shell Material: Fabricated Steel
 - .2 Maximum Working Pressure: 165 PSI
 - .3 Connections to be 150# flanged ANSI raised face.
 - .4 Design and built with the latest ASME pressure vessel code, section VIII, Division 1.
 - .5 Must include a blowdown connection for cleaning.
 - .6 Standard of Acceptance: Armstrong VA-10-U, or approved equivalent.
- .2 Supply and install one (1) Cold Loop High-Capacity Air Vent
 - .1 Install on the cold floor loop above the air separator.
 - .2 Air Elimination Range:
 - .1 150 psi at 250°F
 - .2 175 psi at 150°F
 - .3 Standard of Acceptance: Armstrong AAE-750, or approved equivalent.
- .3 Supply and install one (1) Warm Loop Air Separator (AS-2)
 - .1 Shell Material: Fabricated Steel
 - .2 Maximum Working Pressure: 165 PSI
 - .3 Connections to be 150# flanged ANSI raised face.
 - .4 Design and built with the latest ASME pressure vessel code, section VIII, Division 1.
 - .5 Must include a blowdown connection for cleaning.
 - .6 Standard of Acceptance: Armstrong VA-8-U, or approved equivalent.
- .4 Supply and install one (1) Warm Loop High-Capacity Air Vent
 - .1 Install on the warm floor loop above the air separator.
 - .2 Air Elimination Range:
 - .1 150 psi at 250°F
 - .2 175 psi at 150°F
 - .3 Standard of Acceptance: Armstrong AAE-750, or approved equivalent.
- .5 Supply and install one (1) Cold Loop Expansion Tank (EX-1)
 - .1 Acceptance Volume: 128 gal.
 - .2 Total Volume: 158 USGAL

- .3 Type: Pre-charged heavy-duty butyl diaphragm.
 - .4 Include tank saddles to install horizontally.
 - .5 Shell Material: Carbon Steel
 - .6 Head Material: Carbon Steel
 - .7 Working Temperature: 240°F
 - .8 Working Pressure: 125 PSI
 - .9 ASME Certified Construction
 - .10 Standard of Acceptance: Armstrong AX-260V, or approved equivalent
- .6 Supply and install one (1) Warm Loop Expansion Tank (EX-2)
- .1 Acceptance Volume: 48.5 gal.
 - .2 Total Volume: 60 USGAL
 - .3 Type: Pre-charged heavy-duty butyl diaphragm.
 - .4 Include tank saddles to install horizontally.
 - .5 Shell Material: Carbon Steel
 - .6 Head Material: Carbon Steel
 - .7 Working Temperature: 250°F
 - .8 Working Pressure: 125 PSI
 - .9 ASME Certified Construction
 - .10 Standard of Acceptance: Armstrong AX-100V, or approved equivalent
- .7 Supply and install one (1) Glycol Relief High Capacity Air Vent
- .1 Install on the warm loop.
 - .2 Provide manual isolation valves before the high capacity air vents.
 - .3 Pressure Range: 30-150 PSI
 - .4 Pressure Setting: 100 PSI
 - .5 Maximum Temperature: 250°F
 - .6 Standard of Acceptance: Watts 174A, or approved equivalent.
- .8 Supply and install one (1) Hydraulic Separator (HS-1)
- .1 Size: 2.5"
 - .2 Capacity: 80 GPM
 - .3 Fluid: 40% Ethylene Glycol
 - .4 Standard of Acceptance: Caleffi 548062A, or approved equivalent.
- .9 Where noted in the specifications or the drawings, pressure gauges must meet the following requirements:
- .1 Pressure Range: 0 – 100 PSI
 - .2 Standard of Acceptance: Kodiak Controls Inc. KC201 D25 100
- .10 Where noted in the specifications or the drawings, analog thermometers must meet the following requirements:
- .1 Type: Adjustable angle liquid-in-glass thermometer.

- .2 Range: 0°F to 160°F
- .3 Contractor to include all thermowells as required.
- .4 Standard of Acceptance: Trerice, or approved equivalent.

2.2 Additional Items

- .1 Provide rental refrigeration system connections as detailed on the design drawings.
- .2 Supply and install a new charge of glycol for the installed plant pipe and fully charge the plant system and feeders
 - .1 Contractor to carry all procurement, transportation, testing, and labor required to provide the glycol charge.
 - .2 Fluid: 40% Ethylene Glycol, including all required additives and inhibitors
 - .3 After charging of the system, the Contractor is required to adjust the concentration to the desired amount. Testing must be completed demonstrating that the required concentration has been achieved. Provide all testing reports to the Consultant.
 - .4 Standard of Acceptance: DOW Chemical's Ambitrol FL40, or equivalent.
- .3 Any electrical or fire alarm shutdowns required by the Contractor for the scope of work must be approved by the Owner two (2) weeks prior to being performed for coordination purposes.
- .4 The contractor it to provide two (2) glycol testing reports, one for the cold glycol charge and one for the warm glycol charge. This is to verify the fluid properties and concentration.
- .5 All valves and controls should be located at ergonomic heights unless technically unfeasible.
- .6 Contractor to supply and install an as-built piping schematic and valve chart
- .7 The contractor shall install thermometers on the inlets and outlets of all refrigeration packages, and pressure gauges on all pumps. Pressure gauges are to be dial type and thermometers are analog type as specified.
- .8 Contractor to provide structural steel support members as required for hanging equipment and pipes.
- .9 Cutting, patching, sleeving, sealing, and fireproofing of floor, wall and ceiling necessary for installation of piping system shall be provided by the contractor.

- .10 The contractor shall install dust enclosures while performing work in occupied facility zones, which generates large amounts of particulates.
- .11 The contractor shall carry the cost of all piping, valves, fittings, and adaptors required to make a fully functional system as outlined in the specification herein, even if not specifically mentioned.
- .12 Site cleanup and removal of construction/demolition debris is the responsibility of the contractor.
- .13 Equipment layout shall allow adequate clearances for cleaning and maintenance purposes. The proposed clearances must be documented on a Clearance and Interface drawing and submitted to the Owner and the Consultant for comment, prior to commencing work.
- .14 All installed equipment shall be labelled with placards, and shall be labelled by equipment type in sequential order (Air Separators, Expansion Tanks, etc.).
- .15 Contractor shall seal all building penetrations created/modified under the scope of this contract with a watertight sealant; the penetration shall be painted to match the surrounding building finishes.
- .16 The contractor shall provide all required fluids required for a fully functional and operational system including:
 - .1 Glycol Charge (40%) Plant Room Cold & Warm Glycol
- .17 Prior to commencing work the contractor shall determine the location of any utility entrances (power, water, sewer), which may interfere with carrying out this work. This shall be done in conjunction with the utility companies, and shall be at the cost of the contractor.
- .18 Contractor must pay for all local inspections, approvals, and permits as required for the piping and insulation project.
- .19 Supply and install a glycol drain/charge valve on each pump in the system.
- .20 Contractor to coordinate the installation of all automation valves and instrumentation with the Automation Contractor.

PART 3 – WATER PIPING

3.1 Water Piping General Comments

- .1 All work of this Division shall be coordinated and provided by the Mechanical Contractor.
- .2 All materials shall be first class and new.
- .3 The Mechanical Contractor shall work with the facility, and the Consultant to provide completed hydronic piping in a timely manner.
- .4 The work of this Division shall be as required by the Specifications and Schematic.
- .5 If the Contractor believes there are conflicts or missing information in the project documents, the Contractor shall promptly request clarification and instruction from the Consultant.

3.2 Water Piping Definitions

- .1 Water Piping: Piping which contains water (or a glycol mixture) for the purpose of distribution to loads.
- .2 Mechanical Contractor (or Contractor): The Contractor responsible for supply and installation of all water piping components and requirements as specified.

3.3 Water Piping Description

- .1 The supply and installation of piping, labeling, identification and insulation as outlined.
- .2 The work shall consist of the provision of all labor, materials, tools, equipment, testing, commissioning, training services, transportation, shipping, handling, administration, supervision, management, insurance, temporary protection, cleaning, cutting and patching, warranties, services, and items, even though these may not be specifically mentioned in this documents which are required for the complete, fully functional and commissioned water piping system.
- .3 Provide a complete, neat and workmanlike installation. Use only manufacturers and employees who are skilled, experienced, trained, and familiar with the specific equipment, software, standards and configurations to be provided for this Project.
- .4 Manage and coordinate the work in a timely manner in consideration of the Project schedules. Coordinate with the associated work of other trades so as to not impede or delay the work of associated trades.

3.4 Water Piping Quality Assurance

- .1 General
 - .1 The Contractor shall be a recognized national supplier, installer and service provider for water piping.
 - .2 As part of Risk Management and evidence and assurance of the contractor's ability to support the Owner's system with service and parts, the Contractor must have been in the business for at least the last ten (10) years and have successfully completed a total of ten (10) piping systems in the preceding five (5) years.
- .2 Workplace Safety and Hazardous Materials
 - .1 Provide a safety program in compliance with the Contract Documents.
 - .2 The Contractor shall have a corporately certified comprehensive Safety Certification Manual and a designated Safety Supervisor for the Project.
 - .3 The Contractor and its employees and subtrades comply with federal, state and local safety regulations.
 - .4 The Contractor shall ensure that all subcontractors and employees have written safety programs in place that covers their scope of work, and that their employees receive the training required by the Health and Safety Commission in the jurisdiction for at least each topic listed in the Safety Certification Manual.
 - .5 Hazards created by the Contractor or its subcontractors shall be eliminated before any further work proceeds.
 - .6 Hazards observed but not created by the Contractor or its subcontractors shall be reported to either the Consultant or the Owner within the same day. The Contractor shall be required to avoid the hazard area until the hazard has been eliminated.
 - .7 The Contractor shall sign and date a safety certification form prior to any work being performed, stating that the Contractors' company is in full compliance with the Project safety requirements.
 - .8 The Contractor's safety program shall include written policy and arrangements for the handling, storage and management of all hazardous materials to be used in the work in compliance with the requirements of the Authorities Having Jurisdiction at the Project site.
 - .9 The Contractor's employees and subcontractor's staff shall have received training as applicable in the use of hazardous materials and shall govern their actions accordingly.
- .3 Quality Management Program

- .1 Designate a competent and experienced employee to provide Project Management. The designated Project Manager shall be empowered to make technical, scheduling and related decisions on behalf of the Contractor. At minimum, the Project Manager shall:
 - .1 Manage the scheduling of the work to ensure that adequate materials, labor and other resources are available as needed.
 - .2 Manage the financial aspects of the Contract.
 - .3 Coordinate as necessary with other trades.
 - .4 Be responsible for the work and actions of the workforce on site.

3.5 Water Piping Codes and Standards

- .1 Contractor to comply with all codes and standards applicable to this type of work, including;
 - .1 ASME B31.9 Building Service Piping
 - .2 ASME Boiler and Pressure Vessel Code
 - .3 Local, State and National Building Codes
 - .4 ASHRAE Standards
 - .5 OSHA Regulations
- .2 In the case of conflicts or discrepancies, the more stringent regulation shall apply.
- .3 All work shall meet the approval of the Authorities Having Jurisdiction at the project site.

3.6 Water Piping Record Documentation

- .1 Provide two (2) paper copies and one (1) electronic copy of as-built water piping schematics and layouts for all installed piping covered under this contract.
- .2 Manual shall be bound in 3 ring binders and contain, as a minimum, the following:
 - .1 System operation and maintenance instructions, troubleshooting guidelines and operating log.
 - .2 Safety bulletins and material safety data sheets.
 - .3 Equipment operation and maintenance instructions.
 - .4 Signed Dept. of Labor (or equivalent) Pressure Tests Data Reports
 - .5 Shop drawings of all supplied equipment
- .3 As-built drawings shall contain, typical piping layout, material details, piping connection details, and any additional pertinent details regarding the piping.

3.7 Water Piping Warranty

- .1 Standard Material and Labor Warranty:
 - .1 The Contractor shall provide a one-year labor and material warranty from the date of substantial completion on the water piping system including all valves and fittings.

- .2 If within twelve (12) months from the date of acceptance of product, upon written notice from the owner, any portion of the Water Piping system is found to be defective in operation, workmanship or materials, it shall be replaced, repaired or adjusted at the option of the Contractor and at the cost of the Contractor.

3.8 Water Piping Scope of Work

- .1 Piping shall conform to ASME B31.9 Building Service Piping.
- .2 Piping shall be as follows
 - .1 All Glycol and Water Piping
 - .1 Up to 1 1/2" IPS
 - .1 Schedule 40 ERW OR
 - .2 Schedule 40 Seamless Black Steel Pipe With 150 LB Threaded, OR
 - .3 Schedule 40 3M Socket Weld
 - .2 2" IPS and up
 - .1 Schedule 40 ERW Black Steel Pipe with Standard Butt Weld Fittings,
 - .3 Pipe fittings shall be as follows
 - .1 Steel Piping
 - .1 Flanges ANSI & RF
 - .1 ASTM A105
 - .2 Pressure Rating to Match Design Working Pressure
 - .2 Up to 1 1/2" IPS
 - .1 Threaded – Forged Steel, ASTM A105, 3000 LBS
 - .2 Socket Weld – Forged Steel, ASTM A105, 3000 LBS
 - .3 Butt Weld – Carbon Steel, ASTM SA-234-WPB E.H.
 - .3 2" and Up
 - .1 Socket Weld – Forged Steel, ASTM A105, 3000 LBS
 - .2 Butt Weld – Carbon Steel, ASTM SA-234-WPB STD
 - .2 Copper Piping
 - .1 Up to 4"
 - .1 Join using lead free solder suitable for domestic water system in conformance with ASTM B52 Gr 50A.
 - .2 ATSM B88.
 - .3 Any connections to dissimilar metals to include dielectric union.
 - .4 Piping shall be identified as per Owner's Current Labeling Standards. In the event that no standard is currently in place, labeling shall be as follows.
 - .1 Labeling body shall be Black on Safety Yellow
 - .2 Labeling shall indicate flow of water

- .3 Label Size, text height and placement should conform to ASME A13.1
 - .1 Labels shall be adjacent to all valves and flanges
 - .2 Adjacent to all changes of direction
 - .3 On both sides of a wall or floor penetration
 - .4 At regular intervals on straight runs (maximum 50 feet spacing)

.4 Label Size, and Letter Size

Outside Pipe Diameter, including insulation (in.)	Minimum Label Length (in.)	Minimum Letter Height (in.)
< 1.25	8	0.5
1.5 – 2	8	0.75
2.5 – 6	12	1.25
8 – 10	24	2.5
> 10	32	3.5

- .5 All insulated field fabricated steel piping shall be painted with a rust resistant primer prior to painting and insulation.
 - .1 Standard of Acceptance: Polyguard RG-2400 Primer, or approved equivalent.
- .6 To further protect the piping system, the piping shall be painted.
 - .1 Colors shall match existing color scheme currently utilized at the facility. If no color scheme is present, the following shall be used
 - .1 Light Blue Cold Glycol
 - .2 Dark Blue Warm Glycol
 - .3 Green Domestic Hot and Cold Water

.7 Piping shall be supported as follows

Nominal Diameter Pipe NPS (in.)	Recommended Spacing Between Hangers (ft.)	Minimum Rod Size (in.)
1/2	7	3/8

3/4	7	3/8
1	7	3/8
1-1/2	9	3/8
2	10	3/8
2-1/2	11	1/2
3	12	1/2
4	14	5/8
6	17	3/4
8	19	3/4
10	22	7/8
12	23	7/8
14	25	1
16	27	1
18	28	1
20	30	1-1/4
24	32	1-1/4

- .8 Pipe hangers must include rubber lining on the inside of the clamp to prevent pipe wear, unless the pipe is insulated.
- .9 Mechanical system shut-off valves:
 - .1 All hand shutoff valves shall be ball valves or butterfly valves.
 - .2 Valve type used:
 - .1 1/4" to 2", threaded full port ball valves
 - .2 2 1/2" to 8", full lug type butterfly valves
 - .3 Ball valves to be two (2) piece construction with bronze or steel body, stainless steel ball and manual lever actuator with stem extension. Ball valves to have a rated working pressure of 600 PSIG.
 - .4 Butterfly valves to be full lug style and constructed with ductile iron body, ductile iron nickel plated disc, stainless steel shaft, and BUNA-N seat. Butterfly valve to have rated working pressure of 225 PSIG.
- .10 Valve flow coefficient shall be, at minimum, as per the following. Pressure drop across any fully open valve shall be at maximum 1.5 psi.

Pipe Size (in.)	CV
1-1/2	45
2	75
2-1/2	140
3	240
4	400

5	700
6	1000
8	2100
10	3100
12	4500

.11 Glycol Piping Insulation

- .1 Temperature range: Any
- .2 Insulation Type: Polyiso
- .3 Thickness: 1"
- .4 Jacket Type: PVC
 - .1 Single piece, pre-curved for insulation thickness

.12 Water Piping Insulation

- .1 Temperature range: Any
- .2 Insulation Type: Polyiso
- .3 Thickness: 1"
- .4 Jacket Type: PVC
 - .1 Single piece, pre-curved for insulation thickness

.13 Unless otherwise indicated, all materials must be new, first quality and approved by at least one of the following organizations: ULC, ARI, AMCA, ASME or any other body with jurisdiction in the area concerned.

.14 Piping system test pressures:

- .1 All new piping to be pressure tested. Provide all test results to Owner upon completion.
- .2 Type of test: Hydronic
- .3 Cold Glycol System: 80 PSI.
- .4 Warm Glycol System: 100 PSI.

3.9 Specific Requirements

- .1 The proponent is responsible for:
 - .1 All pipe, valves and fittings shall be installed as per Local, State, and National Code.
 - .2 Construction is to be completed in conjunction with owner.

3.10 Installation Practices

- .1 All piping shall be installed as per manufacturer's specifications in accordance with ASME B31.9 as required.
- .2 All piping shall be installed straight and true, and parallel to all walls.
- .3 All valves and controls should be located at ergonomic heights unless technically unfeasible.

- .4 All valves shall be tagged with identification tags, and a reference key identifying each valve shall be provided with the as-built drawings.
- .5 Piping shall be installed as per the drawings package.
- .6 Piping installed in public spaces where pipes, or valves are easily accessible by the public shall be located inside a metallic mesh cage to prevent damage and unauthorized access.

PART 4 – REFRIGERANT
PIPING

4.1 Refrigerant Piping
General Comments

- .1 All work of this Division shall be coordinated and provided by the Contractor.
- .2 All materials shall be first class and new.
- .3 The Contractor shall work with the facility, and the Consultant to provide completed refrigeration piping in a timely manner.
- .4 The work of this Division shall be as required by the Specifications and Schematic.
- .5 If the Contractor believes there are conflicts or missing information in the project documents, the Contractor shall promptly request clarification and instruction from the design team.
- .6 The following specification is for the refrigerant relief piping from the new refrigeration package(s).

4.2 Refrigerant Piping
Definitions

- .1 Refrigerant Piping: Piping which contains refrigerant as any stage within the refrigeration cycle.
- .2 Refrigerant Relief Piping: Piping specifically used to vent refrigerant to atmosphere, in the event of an emergency or for testing purposes.
- .3 Refrigeration Contractor (or Contractor): The Contractor responsible for supply and installation of all refrigerant piping components and requirements as specified.

4.3 Refrigerant Piping
Description

- .1 The supply and installation of refrigerant piping, labeling, identification and insulation as outlined.
- .2 The work shall consist of the provision of all labor, materials, tools, equipment, testing, commissioning, training services, transportation, shipping, handling, administration, supervision, management, insurance, temporary protection, cleaning, cutting and patching, warranties, services, and items, even though these may not be specifically mentioned in this documents which are required for the complete, fully functional and commissioned refrigerant piping system.

- .3 Provide a complete, neat and workmanlike installation. Use only manufacturers and employees who are skilled, experienced, trained, and familiar with the specific equipment, software, standards and configurations to be provided for this Project.
- .4 Manage and coordinate the work in a timely manner in consideration of the Project schedules. Coordinate with the associated work of other trades so as to not impede or delay the work of associated trades.

4.4 Refrigerant Piping Quality Assurance

- .1 General
 - .1 The Refrigeration Contractor shall be a recognized national supplier, installer and service provider for refrigerant piping.
 - .2 As part of Risk Management and evidence and assurance of the contractor's ability to support the Owner's system with service and parts, the Contractor must have been in the business for at least the last ten (10) years and have successfully completed a total of ten (10) refrigerant piping systems in the preceding five (5) years.
- .2 Workplace Safety and Hazardous Materials
 - .1 Provide a safety program in compliance with the Contract Documents.
 - .2 The Contractor shall have a corporately certified comprehensive Safety Certification Manual and a designated Safety Supervisor for the Project.
 - .3 The Contractor and its employees and subtrades comply with federal, state and local safety regulations.
 - .4 The Contractor shall ensure that all subcontractors and employees have written safety programs in place that covers their scope of work, and that their employees receive the training required by the Health and Safety Commission in the jurisdiction for at least each topic listed in the Safety Certification Manual.
 - .5 Hazards created by the Contractor or its subcontractors shall be eliminated before any further work proceeds.
 - .6 Hazards observed but not created by the Contractor or its subcontractors shall be reported to either the Consultant or the Owner within the same day. The Contractor shall be required to avoid the hazard area until the hazard has been eliminated.
 - .7 The Contractor shall sign and date a safety certification form prior to any work being performed, stating that the Contractors'

company is in full compliance with the Project safety requirements.

- .8 The Contractor's safety program shall include written policy and arrangements for the handling, storage and management of all hazardous materials to be used in the work in compliance with the requirements of the Authorities Having Jurisdiction at the Project site.
- .9 The Contractor's employees and subcontractor's staff shall have received training as applicable in the use of hazardous materials and shall govern their actions accordingly.

.3 Quality Management Program

- .1 Designate a competent and experienced employee to provide Project Management. The designated Project Manager shall be empowered to make technical, scheduling and related decisions on behalf of the Contractor. At minimum, the Project Manager shall:
 - .2 Manage the scheduling of the work to ensure that adequate materials, labor and other resources are available as needed.
 - .3 Manage the financial aspects of the Contract.
 - .4 Coordinate as necessary with other trades.
 - .5 Be responsible for the work and actions of the workforce on site.

4.5 Refrigerant Piping Codes and Standards

- .1 Contractor to comply with all codes and standards applicable to this type of work, including:
 - .1 ASME B31.9 Building Service Piping
 - .2 ASME Boiler and Pressure Vessel Code
 - .3 Local, State and National Building Codes
 - .4 ASHRAE Standards
 - .5 OSHA Regulations
- .2 In the case of conflicts or discrepancies, the more stringent regulation shall apply.
- .3 All work shall meet the approval of the Authorities Having Jurisdiction at the project site.

4.6 Refrigerant Piping Record Documentation

- .1 Provide two (2) paper copies and one (1) electronic copy of as-built refrigerant piping schematics and layouts for all installed piping covered under this contract.
- .2 Manual shall be bound in 3 ring binders and contain, as a minimum, the following:

- .1 System operation and maintenance instructions, troubleshooting guidelines and operating log.
 - .2 Safety bulletins and material safety data sheets.
 - .3 Equipment operation and maintenance instructions.
 - .4 Signed Dept. of Labor (or equivalent) Pressure Tests Data Reports
 - .5 Shop drawings of all supplied equipment
- .3 As-built drawings shall contain, typical piping layout, material details, piping connection details, and any additional pertinent details regarding the piping.

4.7 Refrigerant Piping
Warranty

- .1 Standard Material and Labor Warranty:
- .1 The Contractor shall provide a one-year labor and material warranty from the date of substantial completion on the refrigerant piping system including all valves and fittings.
 - .2 If within twelve (12) months from the date of acceptance of product, upon written notice from the Owner, any portion of the Refrigerant Piping system is found to be defective in operation, workmanship or materials, it shall be replaced, repaired or adjusted at the option of the Contractor and at the cost of the Contractor.

4.8 Refrigerant Piping
Scope of Work

- .1 Refrigerant piping shall conform to ASME B31.5 Refrigeration piping code.
- .2 Refrigerant piping shall be as follows
- .2 Up to 1 1/2" IPS
 - .1 Schedule 80 ASTM A53 Grade A or B Seamless, OR
 - .2 Schedule 80 ASTM A106 Grade A or B Seamless, OR
 - .3 Schedule 80 ASTM A333 Grade 1 or 6 Seamless
 - .3 2" IPS and up
 - .1 Schedule 40 ASTM A53 Grade A or B ERW, OR
 - .2 Schedule 40 ASTM A106 Grade A or B Seamless, OR
 - .3 Schedule 40 ASTM A333 Grade 1 or 6 Seamless
 - .4 All piping shall bear the manufacturers identification and conform to the pervious specifications.
- .3 Refrigerant pipe fittings shall be as follows
- .2 Flanges ANSI & RF
 - .1 ASTM A105
 - .3 Pressure Rating to Match Design Working Pressure
 - .4 Up to 1 1/2" IPS
 - .1 Threaded – Forged Steel, ASTM A105, 3000 LBS

- .2 Socket Weld – Forged Steel, ASTM A105, 3000 LBS
- .3 Butt Weld – Carbon Steel, ASTM SA-234-WPB E.H.
- .5 2” and Up
 - .1 Socket Weld – Forged Steel, ASTM A105, 3000 LBS
 - .2 Butt Weld – Carbon Steel, ASTM SA-234-WPB STD
- .4 Piping shall be identified as per the Refrigeration Pipe Labeling Guide:
 - .1 Labeling body shall be Black on Safety Yellow
 - .2 Labeling shall indicate flow of refrigerant and arrows shall be present on both sides of the label, with arrows wrapping around the entire circumference of the pipe
 - .3 Labeling shall have an abbreviation legend
 - .4 Labeling shall identify the system component as per the table listed below
 - .5 Labeling shall identify refrigerant physical state (Liquid or Vapour)
 - .1 Liquid shall be abbreviated as LIQ and set upon an Orange background
 - .2 Vapour shall be abbreviated as VAP and set upon a Blue background
 - .6 Labeling shall identify the working fluid as refrigerant
 - .7 Labeling shall identify pressure level
 - .1 LOW shall be any pressure below 70 psig and set upon a green background
 - .2 HIGH shall be any pressure above 70 psig and set upon a red background
 - .8 Label Size, text height and placement should conform to ASME A13.1
 - .1 Labels shall be adjacent to all valves and flanges
 - .2 Adjacent to all changes of direction
 - .3 On both sides of a wall or floor penetration
 - .4 At regular intervals on straight runs (maximum 50 feet spacing)
 - .1 BD Booster Discharge
 - .2 CD Condenser
 - .3 DS Defrost Condensate
 - .4 ES Economizer Suction
 - .5 HGD Hot Gas Defrost
 - .6 HPL High Pressure Liquid
 - .7 HSD High Stage Discharge
 - .8 HSS High Stage Suction
 - .9 HTRL High Temperature Recirculated Liquid

- .10 HTRS High Temperature Recirculated Suction
- .11 LTRL Low Temperature Recirculated Liquid
- .12 LTRS Low Temperature Recirculated Suction
- .13 LIC Liquid Injection Cooling
- .14 LSS Low Stage Suction
- .15 RV Relief Vent
- .16 TSR Thermosiphon Return
- .17 TSS Thermosiphon Supply

.5 Label Size, and Letter Size

Outside Pipe Diameter, including insulation (in)	Minimum Label Length (in)	Minimum Letter Height (in)
< 1.25	8	0.5
1.5 – 2	8	0.75
2.5 – 6	12	1.25
8 – 10	24	2.5
> 10	32	3.5

.5 All insulated field fabricated steel piping shall be painted with a rust resistant primer prior to painting and insulation.

- .1 Standard of Acceptance: Polyguard RG-2400 Primer, or approved equivalent.

.6 To further protect the refrigerant piping, the piping shall be painted.

- .1 Colors shall match existing color scheme currently utilized at the facility. If no color scheme is present, the following shall be used
 - .1 Red Compressor High Vapour
 - .2 Yellow Intermediate Pressure
 - .3 Orange High Pressure Liquid
 - .4 Blue Low Pressure Liquid or Vapour
 - .5 Green Water

.7 Refrigerant piping shall be supported as follows

Nominal Diameter Pipe NPS (in)	Recommended Spacing Between Hangers (ft.)	Recommended Rod Size (in)
1/2	7	3/8
3/4	7	3/8
1	7	3/8
1-1/2	9	3/8
2	10	3/8
2-1/2	11	1/2

3	12	1/2
4	14	5/8
6	17	3/4
8	19	3/4
10	22	7/8
12	23	7/8
14	25	1
16	27	1
18	28	1
20	30	1-1/4
24	32	1-1/4

- .8 Refrigerant isolation valves to be Angle or Globe type only.
 - .1 Supply and Return refrigerant valves to compressors shall be Angle type
 - .2 Supply and Return refrigerant valves to Plate and Frames shall be Globe type
 - .3 Supply and Return refrigerant valves to Condenser shall be Globe type
 - .4 Inline refrigerant valves shall be Globe type
- .9 All refrigerant valves to be equipped with seal caps; however, handwheels shall also be provided.
- .10 Refrigerant Valve flow coefficient shall be, at minimum, as per the following

Pipe Size (in)	CV	Equivalent Pipe Length (ft.)
1-1/2	45	11
2	75	26
2-1/2	115	22
3	180	31
4	280	54
5	550	47
6	775	65
8	1300	85
10	2250	97
12	3000	116
14	4000	143
16	5500	155

- .11 Refrigerant systems shall be equipped with Pressure Relief valves. The Relief Valves shall start to function at a pressure not exceeding the design pressure of the system being protected.
 - .1 Stop Valves shall not be located between pressure relief valve and the system, unless when pressure relief valves are installed in parallel.
 - .2 The discharge to atmosphere shall be not less than 15 ft. above the adjoining ground level, and not less than 20 ft. from any window, ventilation opening, pedestrian walkway, or exit.
- .12 Unless otherwise indicated, all materials must be new, first quality and approved by at least one of the following organizations: ULC, ARI, AMCA, ASME or any other body with jurisdiction in the area concerned.
- .13 All refrigerant piping and fittings shall conform to the latest edition of the ASME B31.5 Refrigeration Piping and Heat Transfer Components.

4.9 Refrigerant Piping Specific Requirements

- .1 The contractor shall provide a new refrigerant relief stack, which extends a minimum of 15 ft above the adjoining ground level and is 20 ft from any window, ventilation opening, pedestrian walkway, or building exit.
 - .1 A diffuser and goose-neck must be included on the relief stack to prevent direct spray of refrigerant on personnel in the vicinity and prevent foreign material or debris from entering the discharge piping.
- .2 The proponent is responsible for:
 - .1 All pipe, valves and fittings shall be installed as per code. The pipe sizes and valve equipment list are provided in drawings package.
 - .2 Construction is to be completed in conjunction with the Owner.

4.10 Refrigerant Piping Installation Practices

- .1 All piping shall be installed as per manufacturer's specification.
- .2 Where refrigerant piping must cross an open space that provides a passageway, piping shall be installed no less than 7.5 feet above floor, unless it is against the ceiling of such a space.
- .3 All valves and controls should be located at ergonomic heights unless technically unfeasible.

- .4 All piping shall be installed straight and true, and parallel to all walls.
- .5 Refrigerant piping shall not be installed in an enclosed stairway, stair landing or exit. Piping shall not be installed in an elevator, dumb waiter, or shaft containing a moveable object.
- .6 All refrigerant piping, valves, and fittings shall be free of copper, zinc and its specific alloys.
- .7 All refrigerant valves shall be tagged with identification tags, and a reference key identifying each valve shall be located within the mechanical room.
- .8 Piping and valves shall be installed as per the drawings package.
- .9 Piping installed in public spaces shall be located inside a metallic mesh cage to prevent damage and unauthorized access.

Appendix B

Contract Drawing Package



WWW.IBSTOREY.COM

IBS DRAWING SHEET DEFINITION

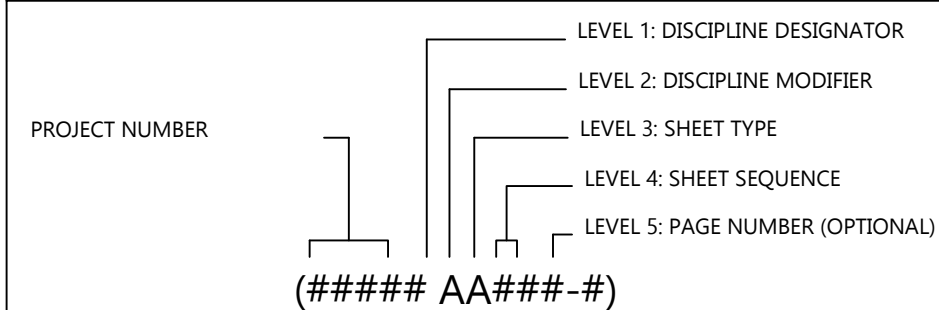

LEVEL 1 DISCIPLINE DESIGNATOR		LEVEL 2 DISCIPLINE MODIFIER		LEVEL 3 SHEET TYPE		LEVEL 4 SHEET SEQUENCE	
A	ARCHITECTURAL	-	MODIFIER NOT USED	0	GENERAL	01-99	SEQUENTIAL VALUE
B	GEOTECHNICAL	M	B BOARDS & GLASS	1	PLANS	ODD	DISTINCT DRAWINGS
C	CIVIL	D	DEMOLITION	2	ELEVATIONS	EVEN	MIRROR DRAWINGS
D	PROCESS	H	HVAC	3	SECTIONS		
E	ELECTRICAL	I	INSTRUMENTATION	4	LARGE-SCALE VIEWS		
F	FIRE PROTECTION	P	PIPING	5	DETAILS		
H	HAZARDOUS MATERIALS	R	RINK FLOOR	6	SCHEDULES & DIAGRAMS		
I	INTERIORS			7	COORDINATION		
L	LANDSCAPE			8	DESIGN STANDARD		
M	MECHANICAL			9	3D REPRESENTATIONS		
O	OPERATIONS						
P	PLUMBING						
Q	EQUIPMENT						
R	RESOURCE						
S	STRUCTURAL						
T	TELECOMMUNICATIONS						
V	SURVEY/MAPPING						
W	DISTRIBUTED ENERGY						
X	OTHER DISCIPLINES						
Z	CONTRACTOR/SHOP DRAWINGS						

REVISION LOG				
DRAWING #	DRAWING NAME	VER:	ISSUED FOR:	DATE
24009 M-605	PIPING SCHEMATICS	VER: 1.0	ISSUED FOR TENDER	21-NOV-24
24009 MP413	PLANT ROOM COOLING PIPING LARGE-SCALE VIEW	VER: 1.0	ISSUED FOR TENDER	21-NOV-24
24009 MP415	PLANT ROOM WARM PIPING LARGE-SCALE VIEW	VER: 1.0	ISSUED FOR TENDER	21-NOV-24
24009 MP417	PLANT ROOM RELIEF PIPING LARGE-SCALE VIEW	VER: 1.0	ISSUED FOR TENDER	21-NOV-24
24009 MP419	PLANT ROOM WATER PIPING LARGE-SCALE VIEW	VER: 1.0	ISSUED FOR TENDER	21-NOV-24
24009 MP421	SNOW MELT PIT PIPING LARGE-SCALE VIEW	VER: 1.0	ISSUED FOR TENDER	21-NOV-24
24009 MP423	PLANT ROOM MISC. EQUIPMENT LARGE-SCALE VIEWS	VER: 1.0	ISSUED FOR TENDER	21-NOV-24
24009 MP911	COOLING PIPING ISOMETRIC VIEW	VER: 1.0	ISSUED FOR TENDER	21-NOV-24
24009 MP913	HEATING PIPING ISOMETRIC VIEW	VER: 1.0	ISSUED FOR TENDER	21-NOV-24
24009 MP915	RELIEF PIPING ISOMETRIC VIEW	VER: 1.0	ISSUED FOR TENDER	21-NOV-24
24009 MP917	WATER PIPING ISOMETRIC VIEW	VER: 1.0	ISSUED FOR TENDER	21-NOV-24
IBSDS M801	GLYCOL RELIEF VALVES STANDARD	VER: 10.0	ISSUED FOR TENDER	30-AUG-24
IBSDS M805	AIR SEPARATOR STANDARD	VER: 12.0	ISSUED FOR TENDER	30-AUG-24
IBSDS M809	GLYCOL FEEDER STANDARD	VER: 10.0	ISSUED FOR TENDER	30-AUG-24
IBSDS M811	EXPANSION TANK STANDARD	VER: 11.0	ISSUED FOR TENDER	30-AUG-24
IBSDS M815	RENTAL CHILLER STANDARD	VER: 4.0	ISSUED FOR TENDER	27-MAR-24

REVISION LOG

NOTES

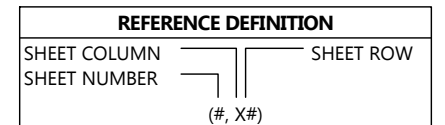

COPYRIGHT AND DISCLAIMER

THIS WORK IS THE SOLE PROPERTY OF I.B. STOREY INC AND IS INTENDED SOLELY FOR THE INFORMATION OF THE CLIENT. ALL RIGHTS RESERVED. THE WORK MAY NOT BE REPRODUCED OR DISTRIBUTED, WHOLE OR IN PART, WITHOUT THE PRIOR WRITTEN PERMISSION OF I.B. STOREY INC. THIS DOCUMENT MAY NOT BE USED FOR ANY OTHER PROJECTS OR WITHOUT INVOLVEMENT OF I.B. STOREY INC. ANY USE WHICH A THIRD PARTY MAKES OF THE WORK, OR ANY RELIANCE ON OR DECISIONS TO BE MADE BASED ON IT, ARE THE RESPONSIBILITY OF SUCH THIRD PARTIES.

- NOT FOR CONSTRUCTION -
CONFIDENTIAL & PROPRIETARY

VER #	REVISIONS	DATE	BY
1.0	ISSUED FOR TENDER	21-NOV-24	H.A.



CHARLOTTETOWN PE
VAUGHAN ON
REDINGTON SHORES FL
PLANO TX

WWW.IBSTOREY.COM

STAMP	
DRAWING NUMBER 24009 PKG02	
DRAWING NAME TP2 PIPING CONNECTIONS & INSULATION	
CLIENT SPRINGFIELD PARK DISTRICT	
PROJECT SPRINGFIELD - PLANT REPLACEMENT	
DRAWN BY H.AKAR	CHECKED BY J.RITCHIE
DATE 21-NOV-24	REVISION 1.0
SHEET SIZE C	SHEET NO. 1 OF 1

24009 PKG02

1

2

3

4

5

NOTE:
 •AUTOMATION VALVES SUPPLIED BY AUTOMATION CONTRACTOR INSTALLED BY PIPING CONTRACTOR.
 •ITP UNITS, PUMP DECKS, AFC UNIT, AND AUTOMATION VALVES SHOWN FOR REFERENCE.

NOTE:
 REFER TO THE TABLE ON THE DESIGN STANDARDS DRAWING

I. B. STOREY DESIGN STANDARDS: 1 (COLD SIDE)
 IBSDS M805 AIR SEPARATOR V12.0 -06
 IBSDS M809 GLYCOL FEEDER V10.0 -0.6
 IBSDS M811 EXPANSION TANK V11.0 -12

I. B. STOREY DESIGN STANDARDS: 2 (WARM SIDE)
 IBSDS M801 GLYCOL RELIEF VALVES V10.0 -0.1
 IBSDS M805 AIR SEPARATOR V12.0 -05
 IBSDS M809 GLYCOL FEEDER V10.0 -0.6
 IBSDS M811 EXPANSION TANK V11.0 -06

I. B. STOREY DESIGN STANDARDS: 3
 IBSDS M815 RENTAL CHILLER V4.0 -01

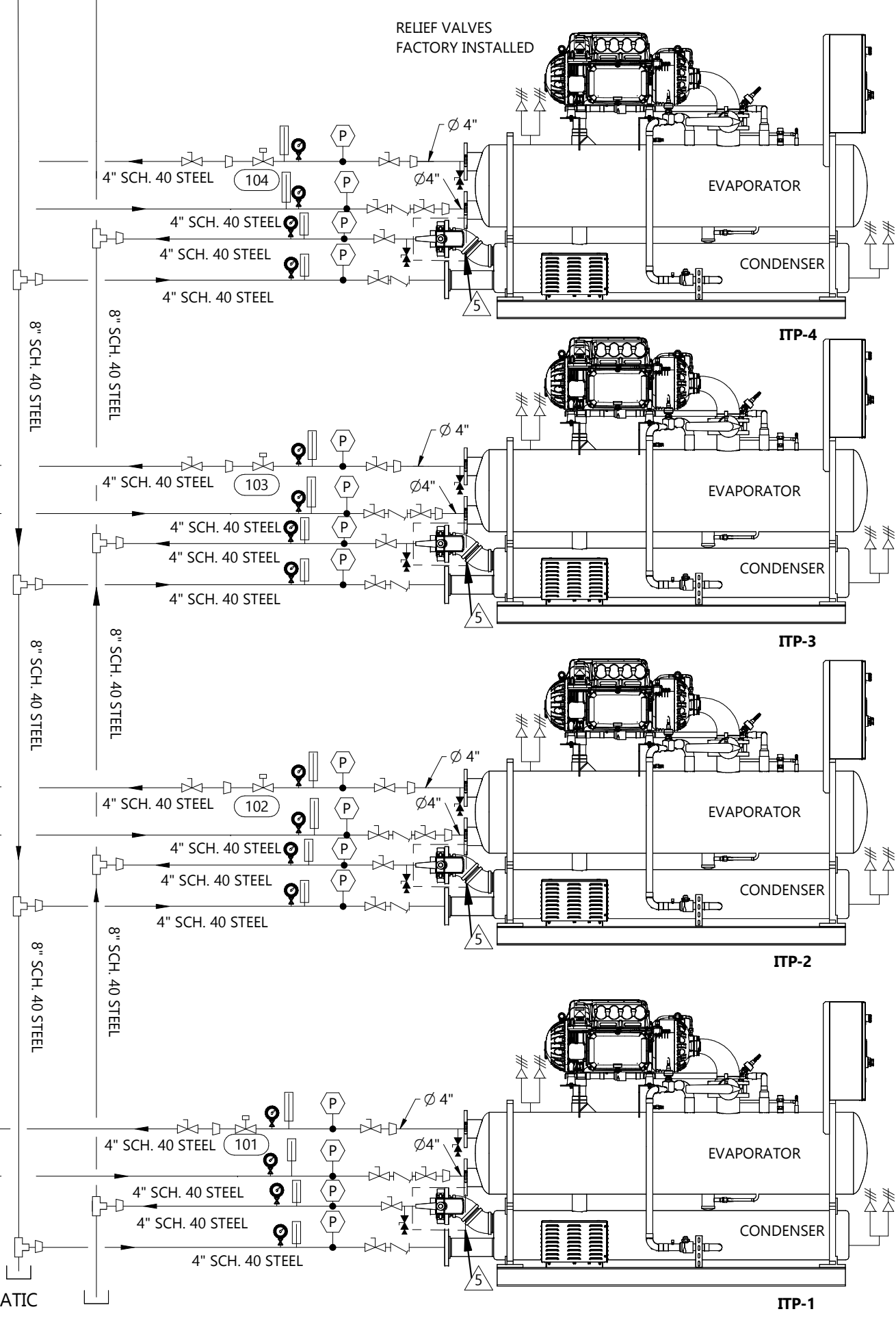
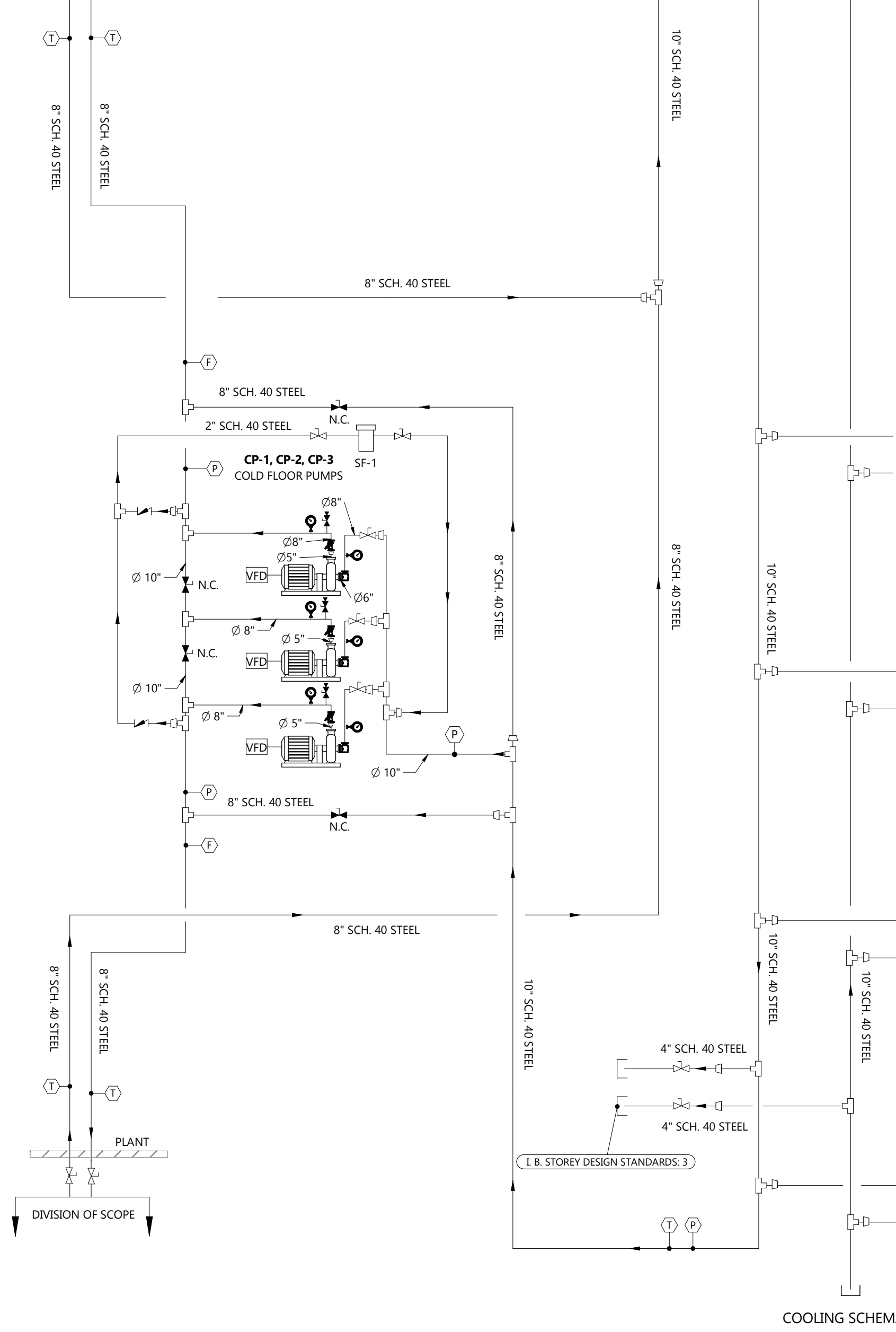
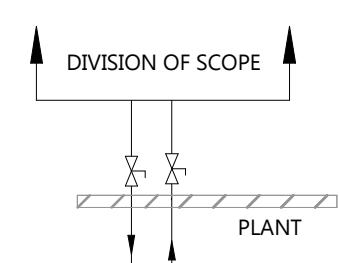
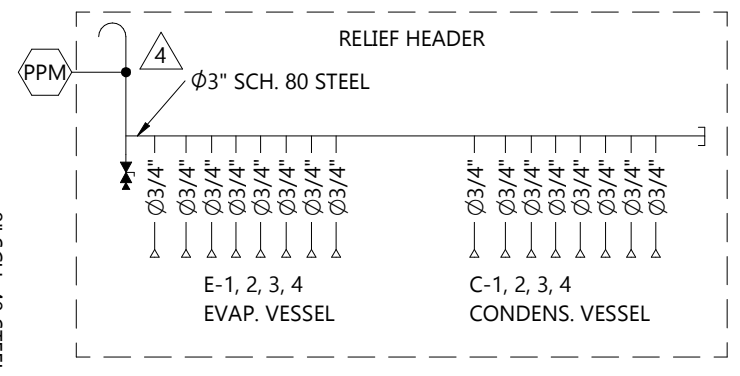

NOTES

	NEW	EXISTING
[Symbol]	ISOLATING VALVE	
[Symbol]	MODULATING VALVE	
[Symbol]	SOLENOID VALVE	
[Symbol]	EXPANSION VALVE	
[Symbol]	RELIEF VALVE	
[Symbol]	STRAINER	
[Symbol]	CHECK VALVE	
[Symbol]	BALANCING VALVE	
[Symbol]	DRAIN	
[Symbol]	FLO-TREX VALVE	
[Symbol]	SUCTION GUIDE	
[Symbol]	PRESSURE SENSOR	
[Symbol]	TEMPERATURE SENSOR	
[Symbol]	FLOW METER	
[Symbol]	LEVEL SWITCH	
[Symbol]	RELIEF LINE	
[Symbol]	PRESSURE GAUGE	
[Symbol]	THERMOMETER	
[Symbol]	REFRIGERANT DETECTOR	

REFERENCE DEFINITION

SHEET COLUMN	SHEET ROW
(#)	(X#)

COPYRIGHT AND DISCLAIMER
 THIS WORK IS THE SOLE PROPERTY OF I.B. STOREY INC AND IS INTENDED SOLELY FOR THE INFORMATION OF THE CLIENT. ALL RIGHTS RESERVED. THE WORK MAY NOT BE REPRODUCED OR DISTRIBUTED, WHOLE OR IN PART, WITHOUT THE PRIOR WRITTEN PERMISSION OF I.B. STOREY INC.
 THIS DOCUMENT MAY NOT BE USED FOR ANY OTHER PROJECTS OR WITHOUT INVOLVEMENT OF I.B. STOREY INC. ANY USE WHICH A THIRD PARTY MAKES OF THE WORK, OR ANY RELIANCE ON OR DECISIONS TO BE MADE BASED ON IT, ARE THE RESPONSIBILITY OF SUCH THIRD PARTIES.

- NOT FOR CONSTRUCTION -
 CONFIDENTIAL & PROPRIETARY

VER #	REVISIONS	DATE	BY
1.0	ISSUED FOR TENDER	21-NOV-24	H.A.

CHARLOTTETOWN PE
 VAUGHAN ON
 REDINGTON SHORES FL
 PLANO TX

WWW.IBSTOREY.COM

STAMP

DRAWING NUMBER	24009 M-605
DRAWING NAME	PIPING SCHEMATIC
CLIENT	SPRINGFIELD PARK DISTRICT
PROJECT	SPRINGFIELD - PLANT REPLACEMENT
DRAWN BY	H.AKAR
CHECKED BY	J.RITCHIE
DATE	21-NOV-24
REVISION	1.0
SHEET SIZE	C
SHEET NO.	1 OF 3

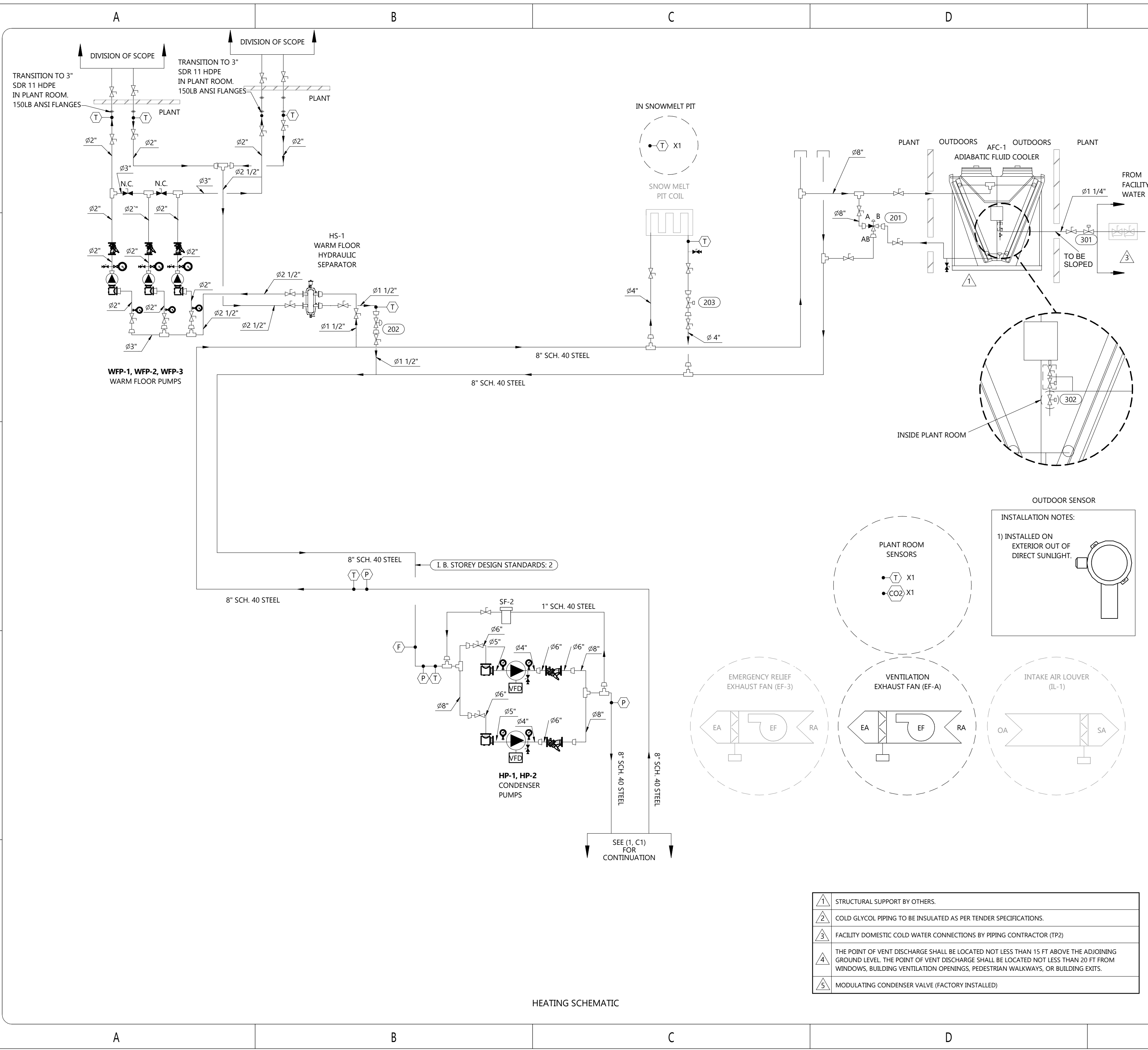

NOTES

—	NEW
- - -	EXISTING

⊗	ISOLATING VALVE
⊕	MODULATING VALVE
⊖	SOLENOID VALVE
⊘	EXPANSION VALVE
⊙	RELIEF VALVE
⊚	STRAINER
⊛	CHECK VALVE
⊜	BALANCING VALVE
⊝	DRAIN
⊞	FLO-TREX VALVE
⊟	SUCTION GUIDE
⊠	PRESSURE SENSOR
⊡	TEMPERATURE SENSOR
⊢	FLOW METER
⊣	LEVEL SWITCH
⊤	RELIEF LINE
⊥	PRESSURE GAUGE
⊦	THERMOMETER
⊧	REFRIGERANT DETECTOR

REFERENCE DEFINITION

SHEET COLUMN SHEET NUMBER (#, X#) SHEET ROW

COPYRIGHT AND DISCLAIMER
 THIS WORK IS THE SOLE PROPERTY OF I.B. STOREY INC AND IS INTENDED SOLELY FOR THE INFORMATION OF THE CLIENT. ALL RIGHTS RESERVED. THE WORK MAY NOT BE REPRODUCED OR DISTRIBUTED, WHOLE OR IN PART, WITHOUT THE PRIOR WRITTEN PERMISSION OF I.B. STOREY INC.
 THIS DOCUMENT MAY NOT BE USED FOR ANY OTHER PROJECTS OR WITHOUT INVOLVEMENT OF I.B. STOREY INC. ANY USE WHICH A THIRD PARTY MAKES OF THE WORK, OR ANY RELIANCE ON OR DECISIONS TO BE MADE BASED ON IT, ARE THE RESPONSIBILITY OF SUCH THIRD PARTIES.

- NOT FOR CONSTRUCTION -
CONFIDENTIAL & PROPRIETARY

1.0	ISSUED FOR TENDER	21-NOV-24	H.A.
VER #	REVISIONS	DATE	BY

I.B. STOREY
 Risk Engineering Experts

CHARLOTTETOWN PE
 VAUGHAN ON
 REDINGTON SHORES FL
 PLANO TX

WWW.IBSTOREY.COM

STAMP

DRAWING NUMBER	24009 M-605
DRAWING NAME	PIPING SCHEMATIC
CLIENT	SPRINGFIELD PARK DISTRICT
PROJECT	SPRINGFIELD - PLANT REPLACEMENT
DRAWN BY	H.AKAR
CHECKED BY	J.RITCHIE
DATE	21-NOV-24
REVISION	1.0
SHEET SIZE	C
SHEET NO.	2 OF 3

- 1. STRUCTURAL SUPPORT BY OTHERS.
- 2. COLD GLYCOL PIPING TO BE INSULATED AS PER TENDER SPECIFICATIONS.
- 3. FACILITY DOMESTIC COLD WATER CONNECTIONS BY PIPING CONTRACTOR (TP2)
- 4. THE POINT OF VENT DISCHARGE SHALL BE LOCATED NOT LESS THAN 15 FT ABOVE THE ADJOINING GROUND LEVEL. THE POINT OF VENT DISCHARGE SHALL BE LOCATED NOT LESS THAN 20 FT FROM WINDOWS, BUILDING VENTILATION OPENINGS, PEDESTRIAN WALKWAYS, OR BUILDING EXITS.
- 5. MODULATING CONDENSER VALVE (FACTORY INSTALLED)

HEATING SCHEMATIC

I.B. STOREY DESIGN STANDARDS SCHEDULE

TAG	DESCRIPTION	QTY.	SERVICE/LOCATION ID	MAX.FLOW, USGPM	MANUFACTURER AND MODEL NO.	ACCEPTANCE VOLUME, USGAL	VOLUME, USGAL	SHIPPING WEIGHT, LB
EX-1	EXP. TANK	1	COLD SIDE	-	ARMSTRONG AX-260V	128	158	812
EX-2	EXP. TANK	1	WARM SIDE	-	ARMSTRONG AX-100V	48.5	60	218
AS-1	AIR SEPARATOR	1	COLD SIDE	1868	VASAME VA-10-U	-	-	390
AS-2	AIR SEPARATOR	1	WARM SIDE	880	VASAME VA-8-U	-	-	228
GF-1	FEEDER	1	COLD SIDE	-	AXIOM SF-100L	-	100	55
GF-2	FEEDER	1	WARM SIDE	-	AXIOM SF-100L	-	100	55

COLD GLYCOL VALVE SCHEDULE (FOR REFERENCE)

TAG	DESCRIPTION	QTY.	FLOW, GPM	PIPE SIZE, IN	VALVE SIZE, IN	VALVE PATTERN	VALVE CV	FAIL STATE	PART #	MANUFACTURER	ACTUATOR CONTROL SIGNAL
101	EVAP	1	467	6	4	2-WAY	600	OPEN	6100HD + DKRX24-3-T	BELIMO	FLOATING / TWO-POSITION
102	EVAP	1	467	6	4	2-WAY	600	OPEN	6100HD + DKRX24-3-T	BELIMO	FLOATING / TWO-POSITION
103	EVAP	1	467	6	4	2-WAY	600	OPEN	6100HD + DKRX24-3-T	BELIMO	FLOATING / TWO-POSITION
104	EVAP	1	467	6	4	2-WAY	600	OPEN	6100HD + DKRX24-3-T	BELIMO	FLOATING / TWO-POSITION
105	STARTUP BYPASS	1	467	6	4	2-WAY	230	OPEN	6100HD + PKRXUP-MFT-T	BELIMO	MODULATING

WARM GLYCOL VALVE SCHEDULE (FOR REFERENCE)

TAG	DESCRIPTION	QTY.	FLOW, GPM	PIPE SIZE, IN	VALVE SIZE, IN	VALVE PATTERN	VALVE CV	FAIL STATE	PART #	MANUFACTURER	ACTUATOR CONTROL SIGNAL
201	ADIABATIC FLUID COOLER BY-PASS	1	880	8	5	3 -WAY	393	MFT PROGRAMMABLE, B-AB FAIL OPEN	F7125HD+PKRXUP-MFT-T	BELIMO	ANALOG MODULATING (0)2-10 VDC
202	UNDER FLOOR	1	12	1 1/2	1/2	2-WAY	7.4	SPRING RETURN, FAIL OPEN	B214+LF24-MFT US	BELIMO	FLOATING / TWO-POSITION
203	SNOW MELT	1	157	4	2 1/2	2-WAY	150	FAIL SAFE CLOSED (FSC) VBN2 ONLY	B264+AFRB24	BELIMO	FLOATING / TWO-POSITION

WATER VALVE SCHEDULE (FOR REFERENCE)

TAG	DESCRIPTION	QTY.	FLOW, GPM	PIPE SIZE, IN	VALVE SIZE	VALVE PATTERN	VALVE CV	FAIL STATE	PART #	MANUFACTURER	ACTUATOR CONTROL SIGNAL
301	WATER IN	1	5	1 1/4	1/2	2-WAY	4.7	CLOSED	B213+LF24-MFT US	BELIMO	FLOATING / TWO-POSITION
302	WATER DRAIN	1	5	1/2	1/2	2-WAY	4.7	OPEN	B213+LF24-MFT US	BELIMO	FLOATING / TWO-POSITION

WARM FLOOR HYDRAULIC SEPARATOR SCHEDULE

TAG	FLUID	QTY.	SIZE IN	CAPACITY, GPM	MANUFACTURER AND MODEL NO.
HS-1	40% E. GLYCOL	1	2.5	80	CALEFFI 548062A

SIDE STREAM FILTER SCHEDULE

TAG	MODEL	SIZE	SIDE STREAM FLOW RATE	FILTER SIZE	VESSEL VOLUME
SF-1	PRM BFHBFH2DCSX	2"	100 GPM	POLYESTER FELT BAG #2 7-1/16" DIA X 32"L	-
SF-2	SFP-20	1"	10-20 GPM	20" DOE COTTON WOUND	0.8 GAL

NOTES

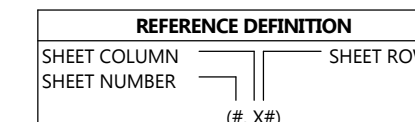

COPYRIGHT AND DISCLAIMER

THIS WORK IS THE SOLE PROPERTY OF I.B. STOREY INC AND IS INTENDED SOLELY FOR THE INFORMATION OF THE CLIENT. ALL RIGHTS RESERVED. THE WORK MAY NOT BE REPRODUCED OR DISTRIBUTED, WHOLE OR IN PART, WITHOUT THE PRIOR WRITTEN PERMISSION OF I.B. STOREY INC. THIS DOCUMENT MAY NOT BE USED FOR ANY OTHER PROJECTS OR WITHOUT INVOLVEMENT OF I.B. STOREY INC. ANY USE WHICH A THIRD PARTY MAKES OF THE WORK, OR ANY RELIANCE ON OR DECISIONS TO BE MADE BASED ON IT, ARE THE RESPONSIBILITY OF SUCH THIRD PARTIES.

**- NOT FOR CONSTRUCTION -
CONFIDENTIAL & PROPRIETARY**

VER #	REVISIONS	DATE	BY
1.0	ISSUED FOR TENDER	21-NOV-24	H.A.



CHARLOTTETOWN PE
VAUGHAN ON
REDINGTON SHORES FL
PLANO TX

WWW.IBSTOREY.COM

STAMP

DRAWING NUMBER	24009 M-605
DRAWING NAME	PIPING SCHEMATIC
CLIENT	SPRINGFIELD PARK DISTRICT
PROJECT	SPRINGFIELD - PLANT REPLACEMENT
DRAWN BY	H.AKAR
CHECKED BY	J.RITCHIE
DATE	21-NOV-24
REVISION	1.0
SHEET SIZE	C
SHEET NO.	3 OF 3

NOTE:
•AUTOMATION VALVES SUPPLIED BY AUTOMATION CONTRACTOR (TP4), INSTALLED BY PIPING CONTRACTOR (TP2)

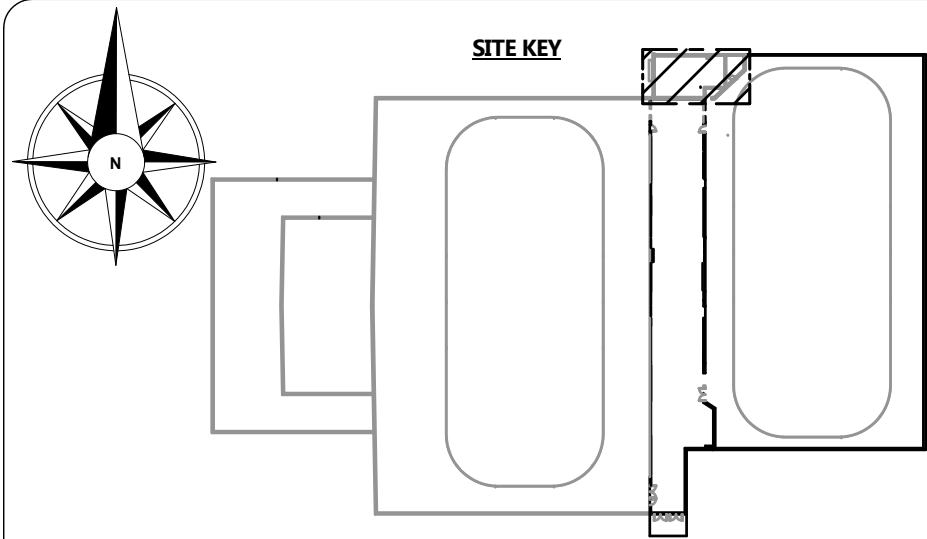

GLYCOL FILLING/TESTING:

- SUPPLY AND INSTALL A NEW CHARGE OF GLYCOL FOR ALL PLANT ROOM EQUIPMENT
- CONTRACTOR TO CARRY ALL PROCUREMENT, TRANSPORTATION, TESTING, AND LABOR REQUIRED TO PROVIDE THE GLYCOL CHARGE
- FLUID: 40% ETHYLENE GLYCOL, INCLUDING ALL REQUIRED ADDITIVES AND INHIBITORS
- AFTER CHARGING OF THE SYSTEM, THE CONTRACTOR IS REQUIRED TO ADJUST THE CONCENTRATION TO THE DESIRED AMOUNT
- TESTING MUST BE COMPLETED DEMONSTRATING THAT THE REQUIRED CONCENTRATION HAS BEEN ACHIEVED. PROVIDE ALL TESTING REPORTS TO THE CONSULTANT
- STANDARD OF ACCEPTANCE: DOW CHEMICAL'S AMBITROL FL40, OR EQUIVALENT

AUTOMATION VALVES:

- INSTALLED BY CONTRACTOR OF THE SCOPE AND SUPPLY BY OTHERS

NOTES

REFERENCE DEFINITION	
SHEET COLUMN	SHEET ROW
SHEET NUMBER	(#, X#)

COPYRIGHT AND DISCLAIMER
 THIS WORK IS THE SOLE PROPERTY OF I.B. STOREY INC AND IS INTENDED SOLELY FOR THE INFORMATION OF THE CLIENT. ALL RIGHTS RESERVED. THE WORK MAY NOT BE REPRODUCED OR DISTRIBUTED, WHOLE OR IN PART, WITHOUT THE PRIOR WRITTEN PERMISSION OF I.B. STOREY INC.
 THIS DOCUMENT MAY NOT BE USED FOR ANY OTHER PROJECTS OR WITHOUT INVOLVEMENT OF I.B. STOREY INC. ANY USE WHICH A THIRD PARTY MAKES OF THE WORK, OR ANY RELIANCE ON OR DECISIONS TO BE MADE BASED ON IT, ARE THE RESPONSIBILITY OF SUCH THIRD PARTIES.

**- NOT FOR CONSTRUCTION -
 CONFIDENTIAL & PROPRIETARY**

VER #	REVISIONS	DATE	BY
1.0	ISSUED FOR TENDER	21-NOV-24	H.D.



CHARLOTTETOWN PE
 VAUGHAN ON
 REDINGTON SHORES FL
 PLANO, TX

WWW.IBSTOREY.COM

DRAWING NUMBER	
24009 MP413	
DRAWING NAME	
PLANT ROOM COOLING PIPING LARGE-SCALE VIEW	
CLIENT	
SPRINGFIELD PARK DISTRICT	
PROJECT	
SPRINGFIELD-PLANT REPLACEMENT	
DRAWN BY	CHECKED BY
H.DHAMELIYA	J.RITCHIE
DATE	REVISION
21-NOV-24	1.0
SHEET SIZE	SHEET NO.
C	1 OF 2

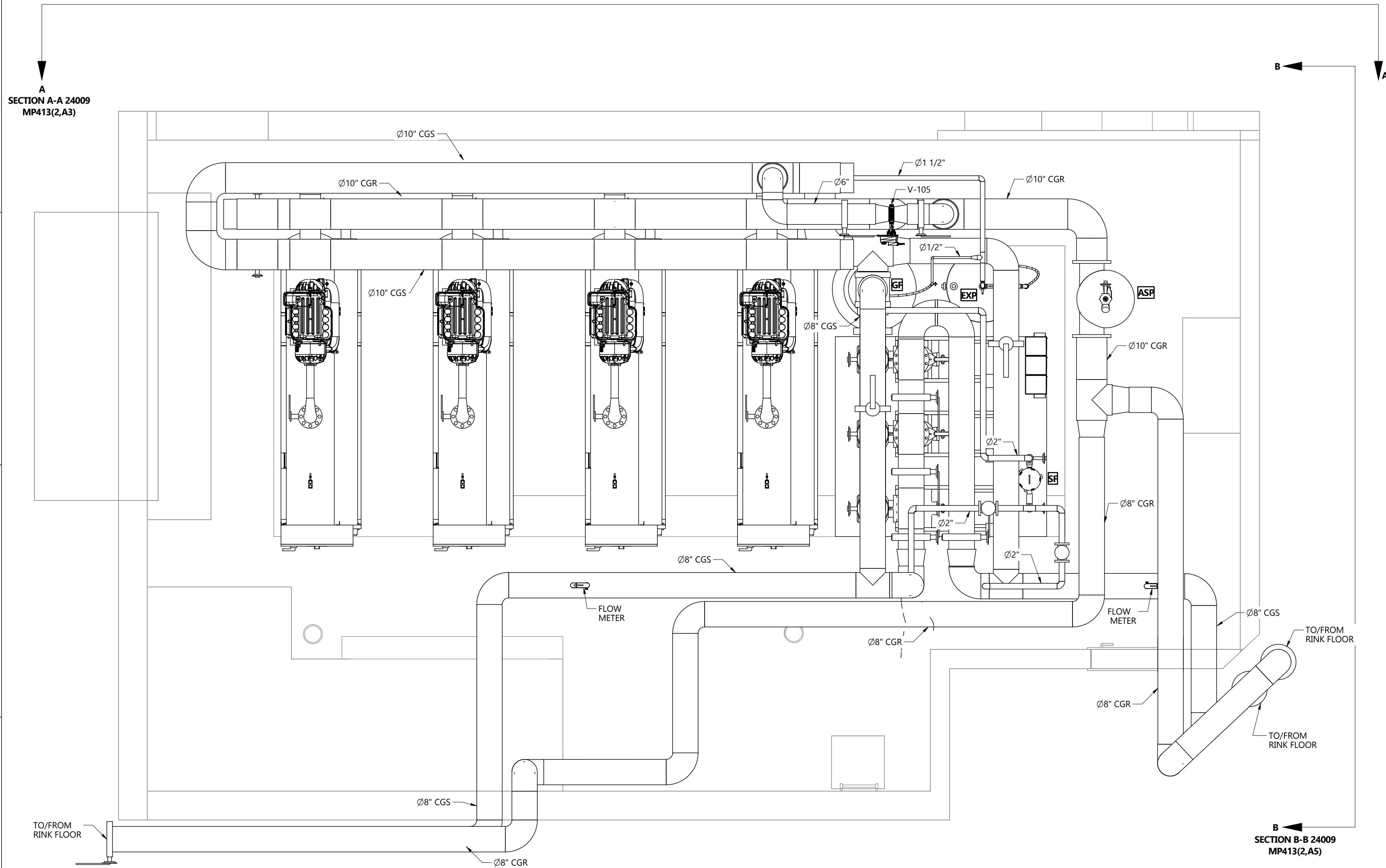

**SECTION A-A 24009
 MP413(2,A3)**

**SECTION B-B 24009
 MP413(2,A5)**

COOLING PIPING PLAN
 SCALE 3/8" = 1'-0"

COOLING PIPING PLAN

24009 MP413

1

2

3

4

5

NOTES

REFERENCE DEFINITION	
SHEET COLUMN	SHEET ROW
(#, X#)	

COPYRIGHT AND DISCLAIMER
 THIS WORK IS THE SOLE PROPERTY OF I.B. STOREY INC AND IS INTENDED SOLELY FOR THE INFORMATION OF THE CLIENT. ALL RIGHTS RESERVED. THE WORK MAY NOT BE REPRODUCED OR DISTRIBUTED, WHOLE OR IN PART, WITHOUT THE PRIOR WRITTEN PERMISSION OF I.B. STOREY INC.
 THIS DOCUMENT MAY NOT BE USED FOR ANY OTHER PROJECTS OR WITHOUT INVOLVEMENT OF I.B. STOREY INC. ANY USE WHICH A THIRD PARTY MAKES OF THE WORK, OR ANY RELIANCE ON OR DECISIONS TO BE MADE BASED ON IT, ARE THE RESPONSIBILITY OF SUCH THIRD PARTIES.

- NOT FOR CONSTRUCTION -
 CONFIDENTIAL & PROPRIETARY

1.0	ISSUED FOR TENDER	21-NOV-24	H.D.
VER #	REVISIONS	DATE	BY



CHARLOTTETOWN PE
 VAUGHAN ON
 REDINGTON SHORES FL
 PLANO, TX

WWW.IBSTOREY.COM

STAMP

DRAWING NUMBER		24009 MP413	
DRAWING NAME			
PLANT ROOM COOLING PIPING LARGE-SCALE VIEW			
CLIENT			
SPRINGFIELD PARK DISTRICT			
PROJECT			
SPRINGFIELD-PLANT REPLACEMENT			
DRAWN BY	H.DHAMELIYA	CHECKED BY	J.RITCHIE
DATE	21-NOV-24	REVISION	1.0
SHEET SIZE	C	SHEET NO.	2 OF 2

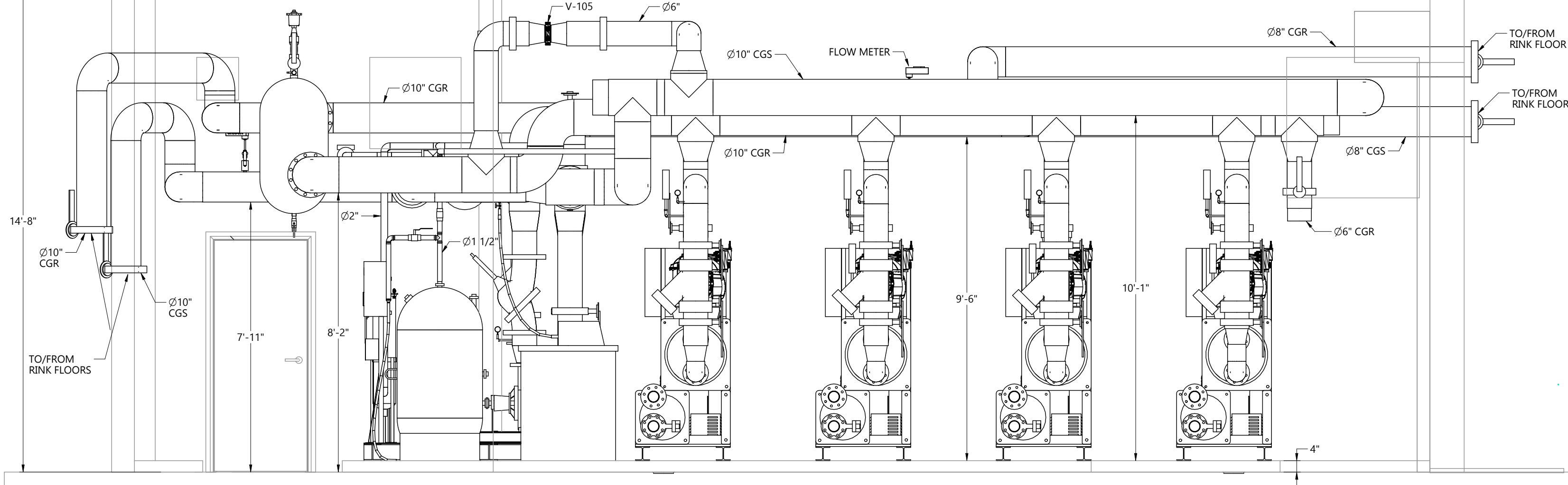

SECTION VIEW A-A 180° (24009 MP413.1.A2)
 SCALE 3/8" = 1'-0"

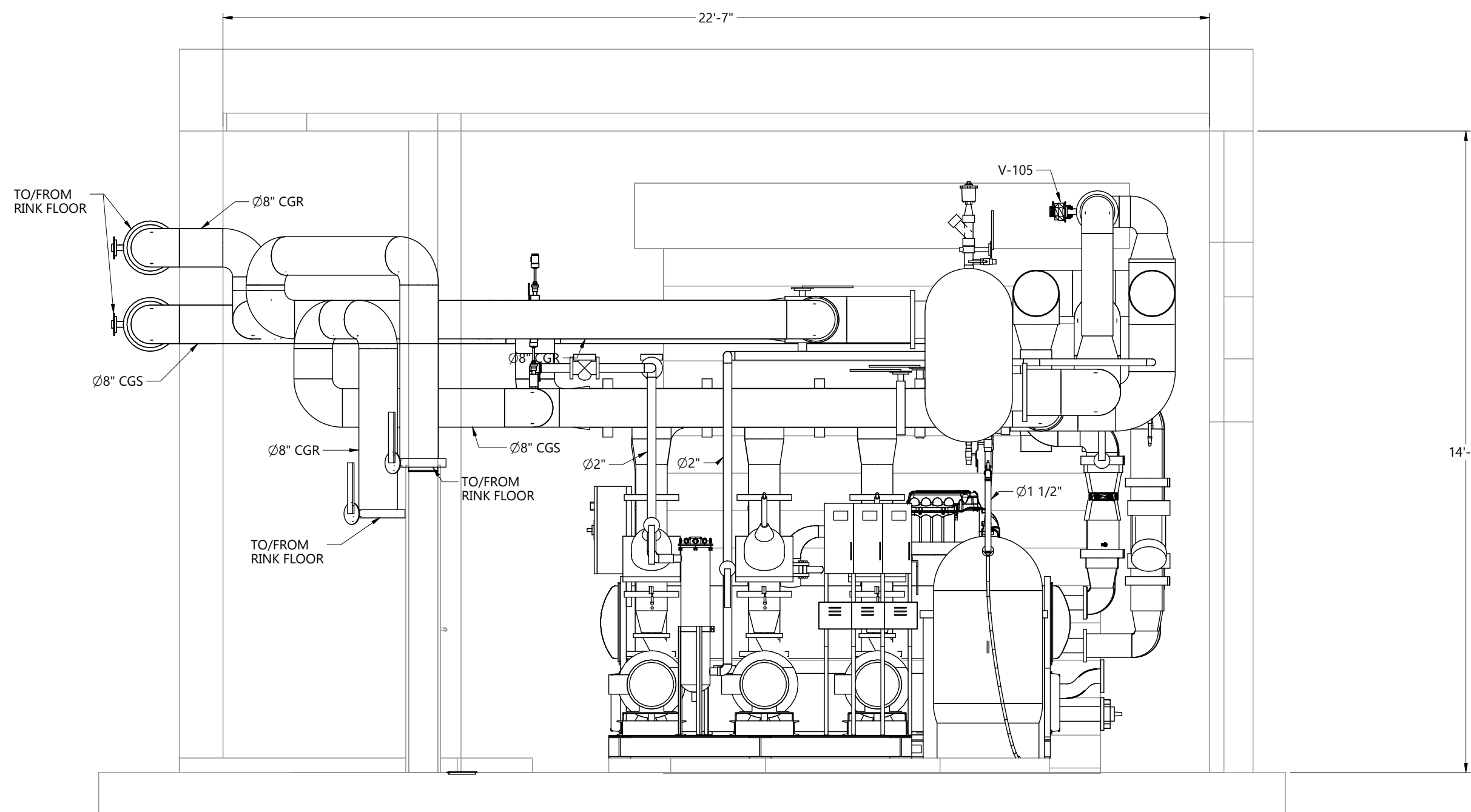

SECTION VIEW G-G 90° (24009 MP413.1.D5)
 SCALE 3/8" = 1'-0"

COOLING PIPING SECTION VIEWS

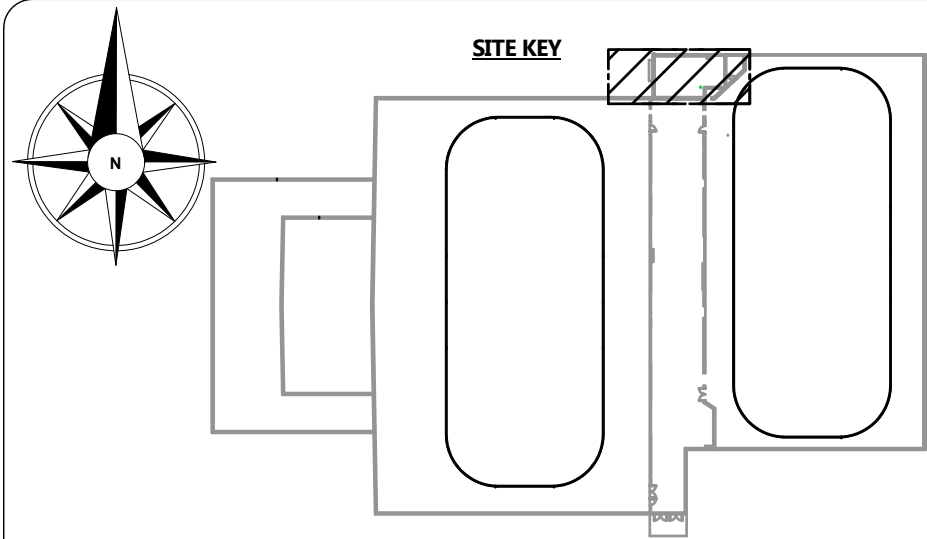

GLYCOL FILLING/TESTING:

- SUPPLY AND INSTALL A NEW CHARGE OF GLYCOL FOR ALL PLANT ROOM EQUIPMENT
- CONTRACTOR TO CARRY ALL PROCUREMENT, TRANSPORTATION, TESTING, AND LABOR REQUIRED TO PROVIDE THE GLYCOL CHARGE
- FLUID: 40% ETHYLENE GLYCOL, INCLUDING ALL REQUIRED ADDITIVES AND INHIBITORS
- AFTER CHARGING OF THE SYSTEM, THE CONTRACTOR IS REQUIRED TO ADJUST THE CONCENTRATION TO THE DESIRED AMOUNT
- TESTING MUST BE COMPLETED DEMONSTRATING THAT THE REQUIRED CONCENTRATION HAS BEEN ACHIEVED. PROVIDE ALL TESTING REPORTS TO THE CONSULTANT
- STANDARD OF ACCEPTANCE: DOW CHEMICAL'S AMBITROL FL40, OR EQUIVALENT

AUTOMATION VALVES:

- INSTALLED BY CONTRACTOR OF THE SCOPE AND SUPPLY BY OTHERS

NOTES

REFERENCE DEFINITION	
SHEET COLUMN	SHEET ROW
SHEET NUMBER	(#, X#)

COPYRIGHT AND DISCLAIMER

THIS WORK IS THE SOLE PROPERTY OF I.B. STOREY INC AND IS INTENDED SOLELY FOR THE INFORMATION OF THE CLIENT. ALL RIGHTS RESERVED. THE WORK MAY NOT BE REPRODUCED OR DISTRIBUTED, WHOLE OR IN PART, WITHOUT THE PRIOR WRITTEN PERMISSION OF I.B. STOREY INC. THIS DOCUMENT MAY NOT BE USED FOR ANY OTHER PROJECTS OR WITHOUT INVOLVEMENT OF I.B. STOREY INC. ANY USE WHICH A THIRD PARTY MAKES OF THE WORK, OR ANY RELIANCE ON OR DECISIONS TO BE MADE BASED ON IT, ARE THE RESPONSIBILITY OF SUCH THIRD PARTIES.

- NOT FOR CONSTRUCTION -
CONFIDENTIAL & PROPRIETARY

VER #	ISSUED FOR TENDER	DATE	H.D.
1.0	ISSUED FOR TENDER	21-NOV-24	H.D.
VER #	REVISIONS	DATE	BY



CHARLOTTETOWN PE
VAUGHAN ON
REDINGTON SHORES FL
PLANO, TX

WWW.IBSTOREY.COM

STAMP

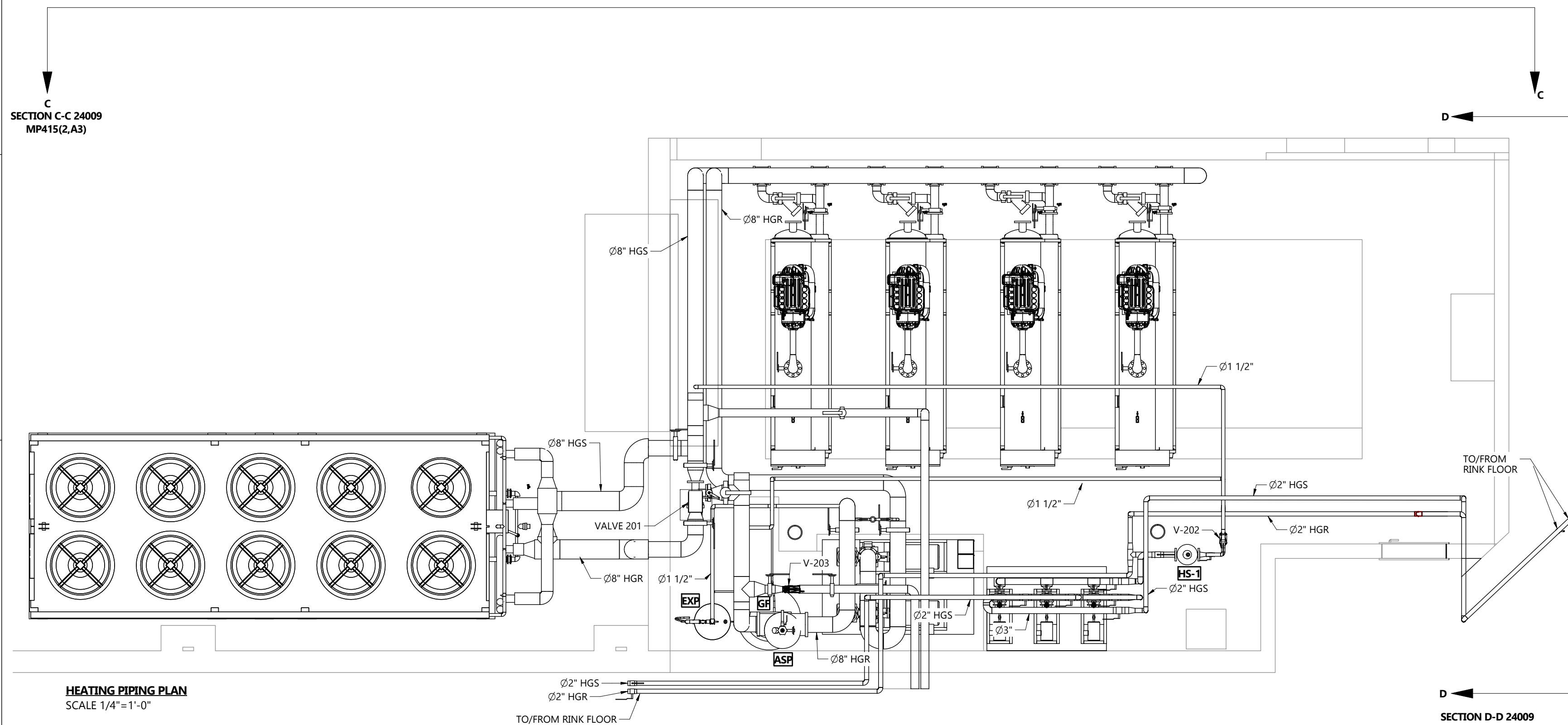

HEATING PIPING PLAN
SCALE 1/4" = 1'-0"

HEATING PIPING PLAN

DRAWING NUMBER		24009 MP415	
DRAWING NAME			
PLANT ROOM WARM PIPING LARGE-SCALE VIEW			
CLIENT			
SPRINGFIELD PARK DISTRICT			
PROJECT			
SPRINGFIELD-PLANT REPLACEMENT			
DRAWN BY	CHECKED BY		
H.DHAMELIYA	J.RITCHIE		
DATE	REVISION		
21-NOV-24	1.0		
SHEET SIZE	SHEET NO.		
C	1 OF 2		

24009 MP405

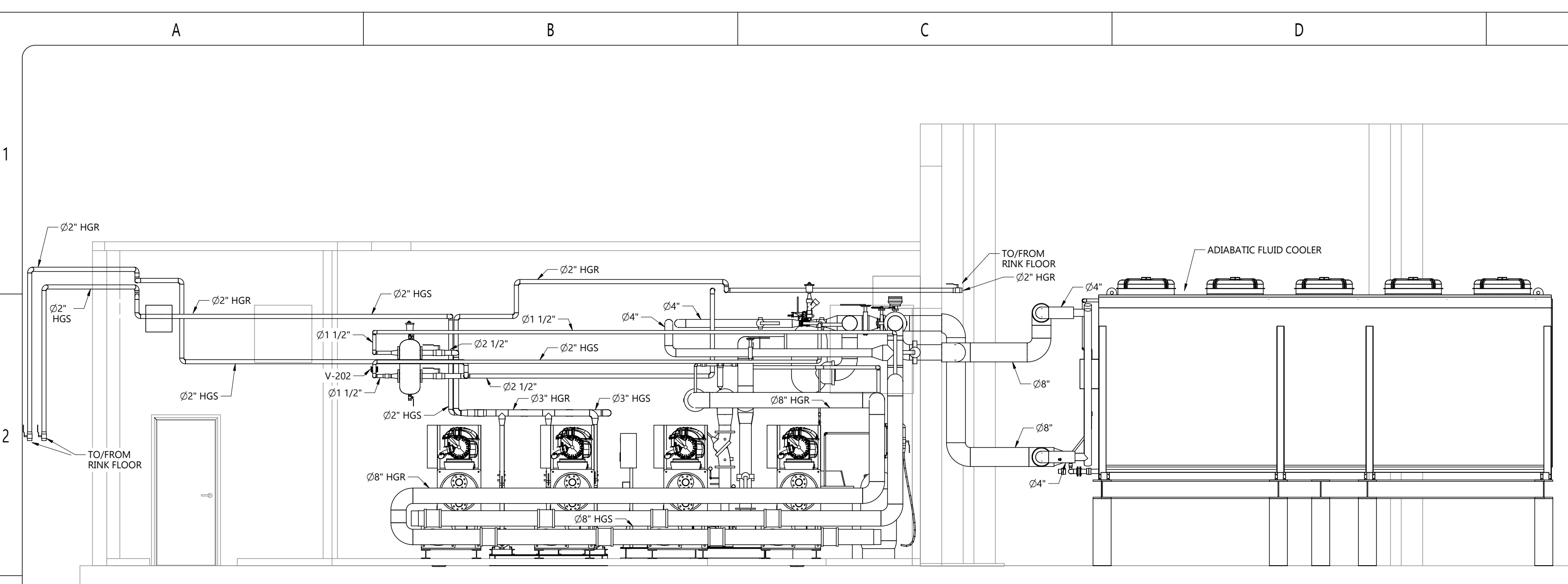

SECTION VIEW C-C 180° (24009 MP415.1.A2)
SCALE 1/4" = 1'-0"

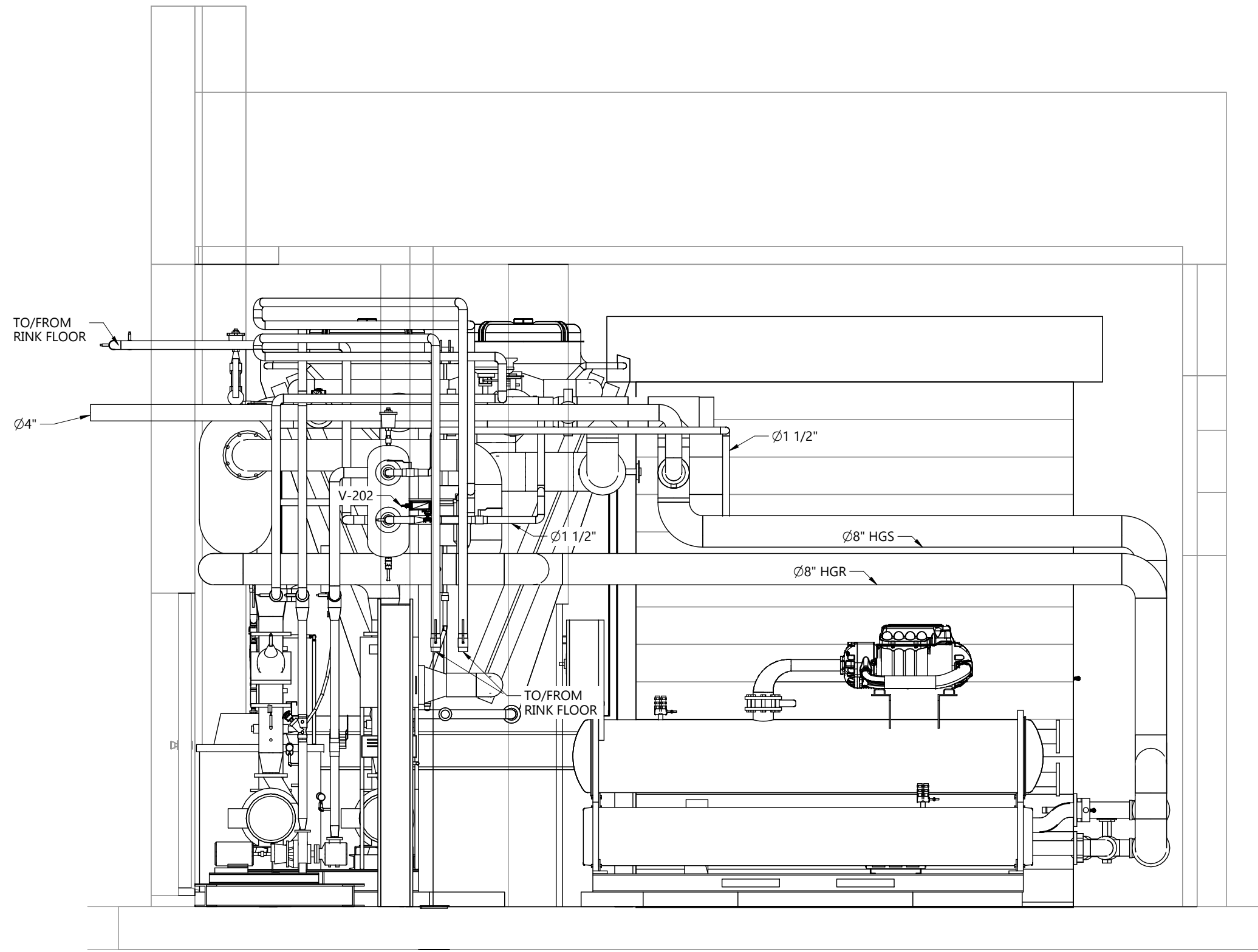

SECTION VIEW D-D 90° (24009 MP415.1.D5)
SCALE 3/8" = 1'-0"

HEATING PIPING SECTION VIEWS

NOTES

REFERENCE DEFINITION	
SHEET COLUMN	SHEET ROW
SHEET NUMBER	(#, X#)

COPYRIGHT AND DISCLAIMER
THIS WORK IS THE SOLE PROPERTY OF I.B. STOREY INC AND IS INTENDED SOLELY FOR THE INFORMATION OF THE CLIENT. ALL RIGHTS RESERVED. THE WORK MAY NOT BE REPRODUCED OR DISTRIBUTED, WHOLE OR IN PART, WITHOUT THE PRIOR WRITTEN PERMISSION OF I.B. STOREY INC.
THIS DOCUMENT MAY NOT BE USED FOR ANY OTHER PROJECTS OR WITHOUT INVOLVEMENT OF I.B. STOREY INC. ANY USE WHICH A THIRD PARTY MAKES OF THE WORK, OR ANY RELIANCE ON OR DECISIONS TO BE MADE BASED ON IT, ARE THE RESPONSIBILITY OF SUCH THIRD PARTIES.

- NOT FOR CONSTRUCTION -
CONFIDENTIAL & PROPRIETARY

VER #	REVISIONS	DATE	BY
1.0	ISSUED FOR TENDER	21-NOV-24	H.D.



CHARLOTTETOWN PE
VAUGHAN ON
REDINGTON SHORES FL
PLANO, TX

WWW.IBSTOREY.COM

DRAWING NUMBER	
24009 MP415	
DRAWING NAME	
PLANT ROOM WARM PIPING LARGE-SCALE VIEW	
CLIENT	
SPRINGFIELD PARK DISTRICT	
PROJECT	
SPRINGFIELD-PLANT REPLACEMENT	
DRAWN BY	CHECKED BY
H.DHAMELIYA	J.RITCHIE
DATE	REVISION
21-NOV-24	1.0
SHEET SIZE	SHEET NO.
C	2 OF 2

24009 MP405

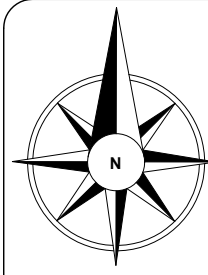

SITE KEY

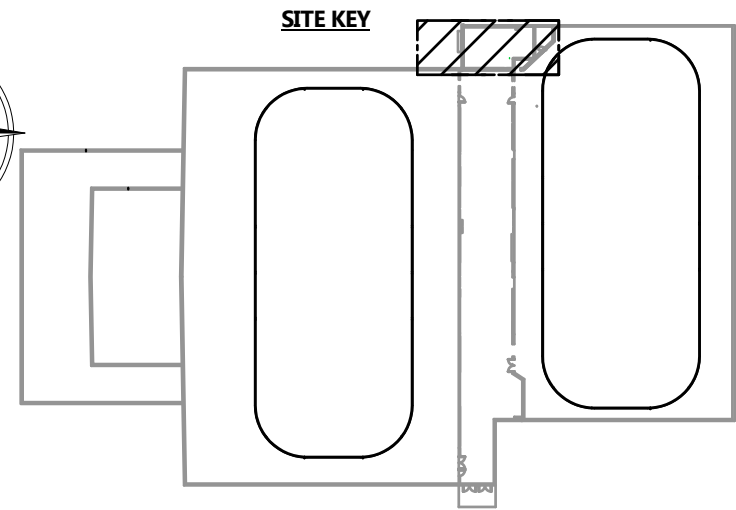

AUTOMATION VALVES:

- INSTALLED BY CONTRACTOR OF THE SCOPE AND SUPPLY BY OTHERS
- PIPE CAPS FOR RELIEF MUST BE RATED FOR MINIMUM 350 PSI

NOTES

—	NEW
- - -	EXISTING
	ISOLATING VALVE
	MODULATING VALVE
	SOLENOID VALVE
	EXPANSION VALVE
	RELIEF VALVE
	SAND FILTER
	STRAINER
	CHECK VALVE
	BALANCING VALVE
	PRESSURE SENSOR
	TEMPERATURE SENSOR
	FLOW METER
	LEVEL SWITCH
	RELIEF LINE

REFERENCE DEFINITION	
SHEET COLUMN	SHEET ROW
SHEET NUMBER	(#, X#)

COPYRIGHT AND DISCLAIMER
 THIS WORK IS THE SOLE PROPERTY OF I.B. STOREY INC AND IS INTENDED SOLELY FOR THE INFORMATION OF THE CLIENT. ALL RIGHTS RESERVED. THE WORK MAY NOT BE REPRODUCED OR DISTRIBUTED, WHOLE OR IN PART, WITHOUT THE PRIOR WRITTEN PERMISSION OF I.B. STOREY INC.
 THIS DOCUMENT MAY NOT BE USED FOR ANY OTHER PROJECTS OR WITHOUT INVOLVEMENT OF I.B. STOREY INC. ANY USE WHICH A THIRD PARTY MAKES OF THE WORK, OR ANY RELIANCE ON OR DECISIONS TO BE MADE BASED ON IT, ARE THE RESPONSIBILITY OF SUCH THIRD PARTIES.

- NOT FOR CONSTRUCTION -
 CONFIDENTIAL & PROPRIETARY

1.0	ISSUED FOR TENDER	21-NOV-24	V.K.
VER #	REVISIONS	DATE	BY



CHARLOTTETOWN PE
 VAUGHAN ON
 REDINGTON SHORES FL
 PLANO TX

WWW.IBSTOREY.COM

STAMP

DRAWING NUMBER		24009 MP417
DRAWING NAME		PLANT ROOM RELIEF PIPING LARGE-SCALE VIEW
CLIENT		SPRINGFIELD PARK DISTRICT
PROJECT		SPRINGFIELD-PLANT REPLACEMENT
DRAWN BY	CHECKED BY	
V.KOFANOV	J.RITCHIE	
DATE	REVISION	
21-NOV-24	1.0	
SHEET SIZE	SHEET NO.	
C	1 OF 2	

SECTION E-E 24009
 MP417(2,A3)

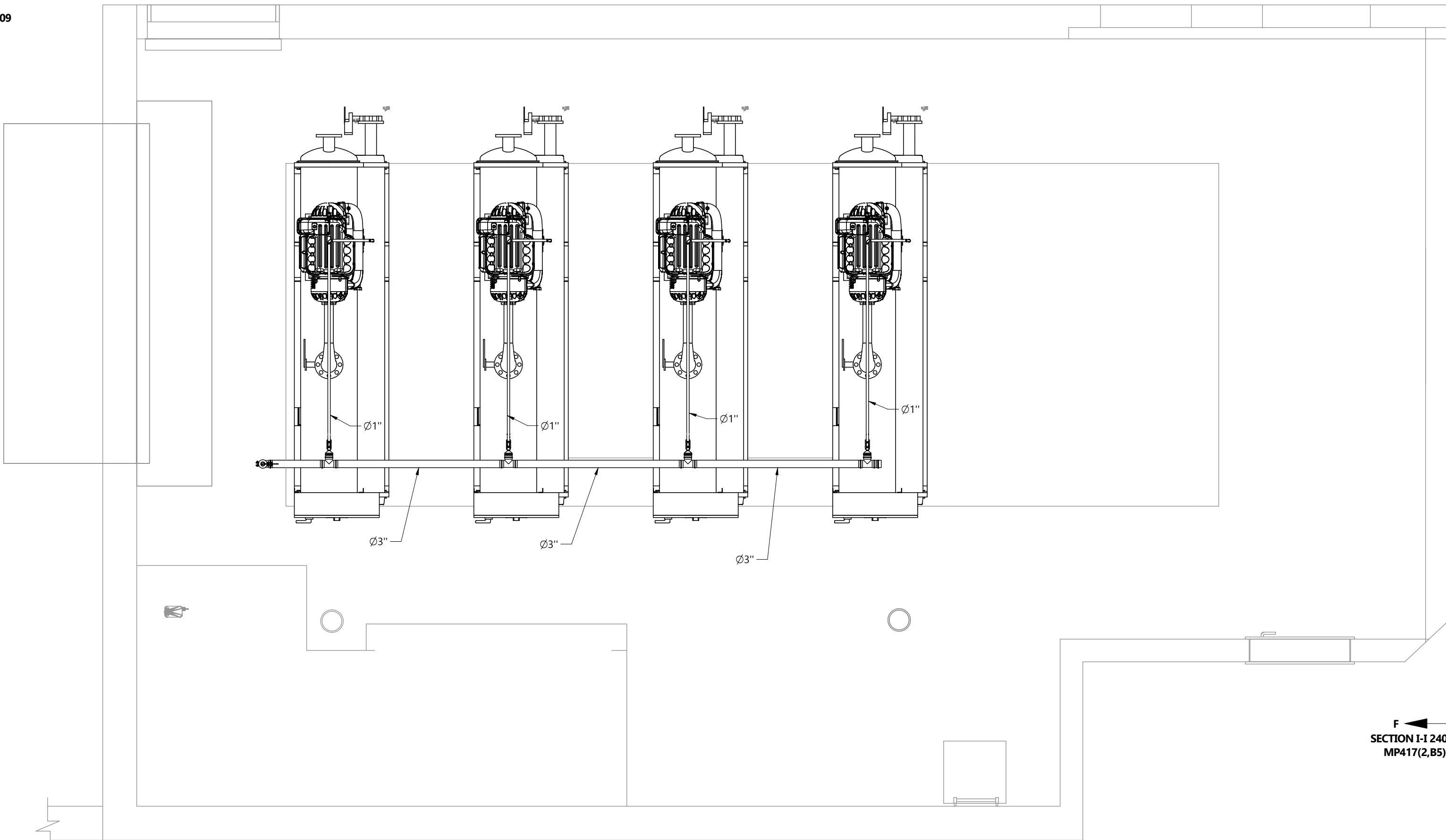

RELIEF PIPING PLAN
 SCALE 3/8" = 1'-0"

RELIEF PIPING PLAN

24009 MP417

1

2

3

4

5

A

B

C

D

E

A

B

C

D

E

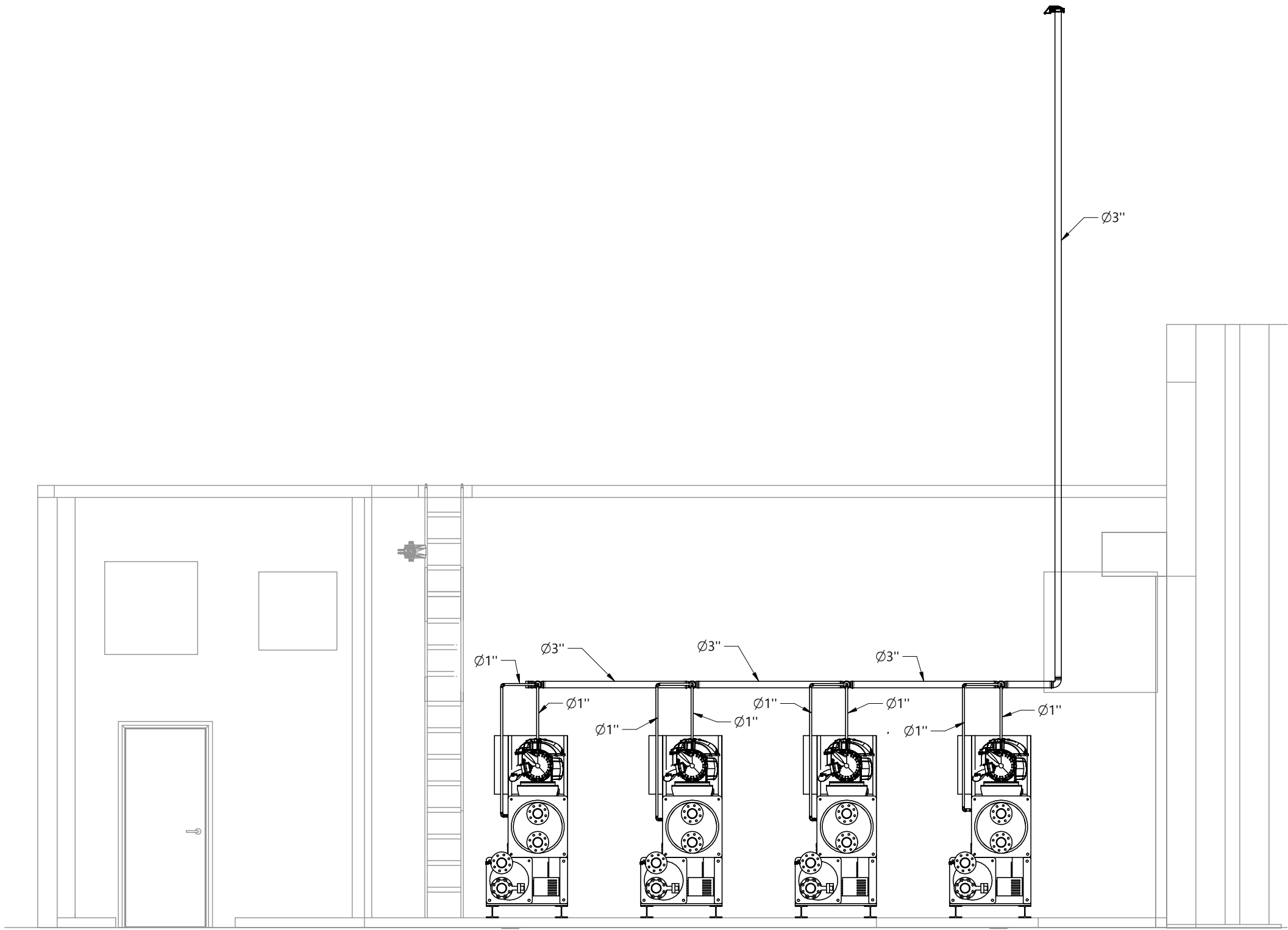

SECTION VIEW E-E (24009 MP417, 1, A1)
SCALE 1/4"=1'-0"

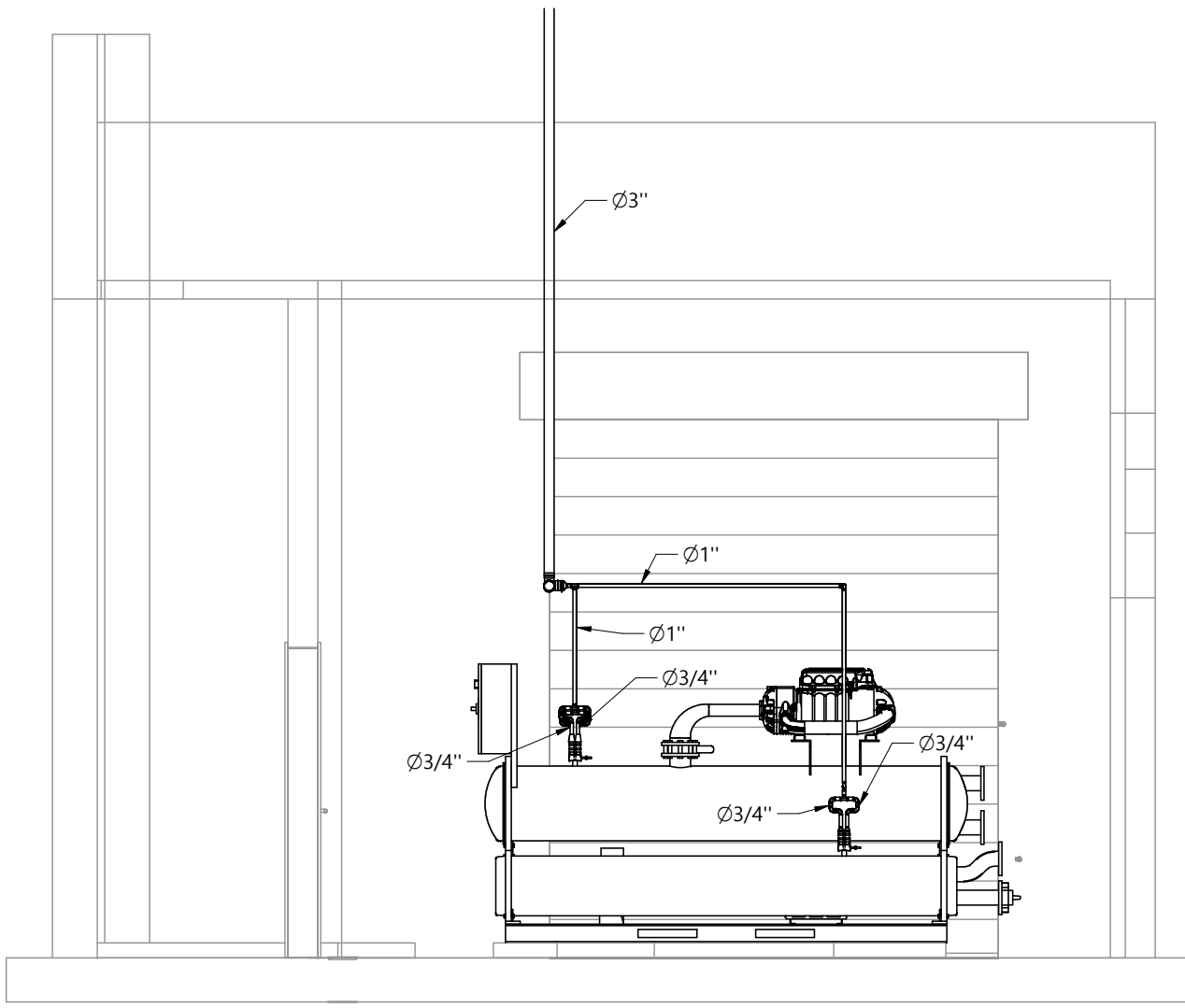

SECTION VIEW F-F (24009 MP417, 1, D4)
SCALE 1/4"=1'-0"

RELIEF PIPING SECTION VIEWS

- NOTE
- PIPE CAPS FOR RELIEF MUST BE RATED FOR MINIMUM 350 PSI

NOTES

---	NEW
---	EXISTING

	ISOLATING VALVE
	MODULATING VALVE
	SOLENOID VALVE
	EXPANSION VALVE
	RELIEF VALVE
	SAND FILTER
	STRAINER
	CHECK VALVE
	BALANCING VALVE
	PRESSURE SENSOR
	TEMPERATURE SENSOR
	FLOW METER
	LEVEL SWITCH
	RELIEF LINE

REFERENCE DEFINITION

SHEET COLUMN	SHEET ROW
SHEET NUMBER	(#, X#)

COPYRIGHT AND DISCLAIMER
THIS WORK IS THE SOLE PROPERTY OF I.B. STOREY INC AND IS INTENDED SOLELY FOR THE INFORMATION OF THE CLIENT. ALL RIGHTS RESERVED. THE WORK MAY NOT BE REPRODUCED OR DISTRIBUTED, WHOLE OR IN PART, WITHOUT THE PRIOR WRITTEN PERMISSION OF I.B. STOREY INC.
THIS DOCUMENT MAY NOT BE USED FOR ANY OTHER PROJECTS OR WITHOUT INVOLVEMENT OF I.B. STOREY INC. ANY USE WHICH A THIRD PARTY MAKES OF THE WORK, OR ANY RELIANCE ON OR DECISIONS TO BE MADE BASED ON IT, ARE THE RESPONSIBILITY OF SUCH THIRD PARTIES.
- NOT FOR CONSTRUCTION -
CONFIDENTIAL & PROPRIETARY

1.0	ISSUED FOR TENDER	21-NOV-24	V.K.
VER #	REVISIONS	DATE	BY

CHARLOTTETOWN PE
VAUGHAN ON
REDINGTON SHORES FL
PLANO TX
WWW.IBSTOREY.COM

STAMP

DRAWING NUMBER 24009 MP417	
DRAWING NAME PLANT ROOM RELIEF PIPING LARGE-SCALE VIEW	
CLIENT SPRINGFIELD PARK DISTRICT	
PROJECT SPRINGFIELD-PLANT REPLACEMENT	
DRAWN BY V.KOFANOV	CHECKED BY J.RITCHIE
DATE 21-NOV-24	REVISION 1.0
SHEET SIZE C	SHEET NO. 2 OF 2

24009 MP417

1

2

3

4

5

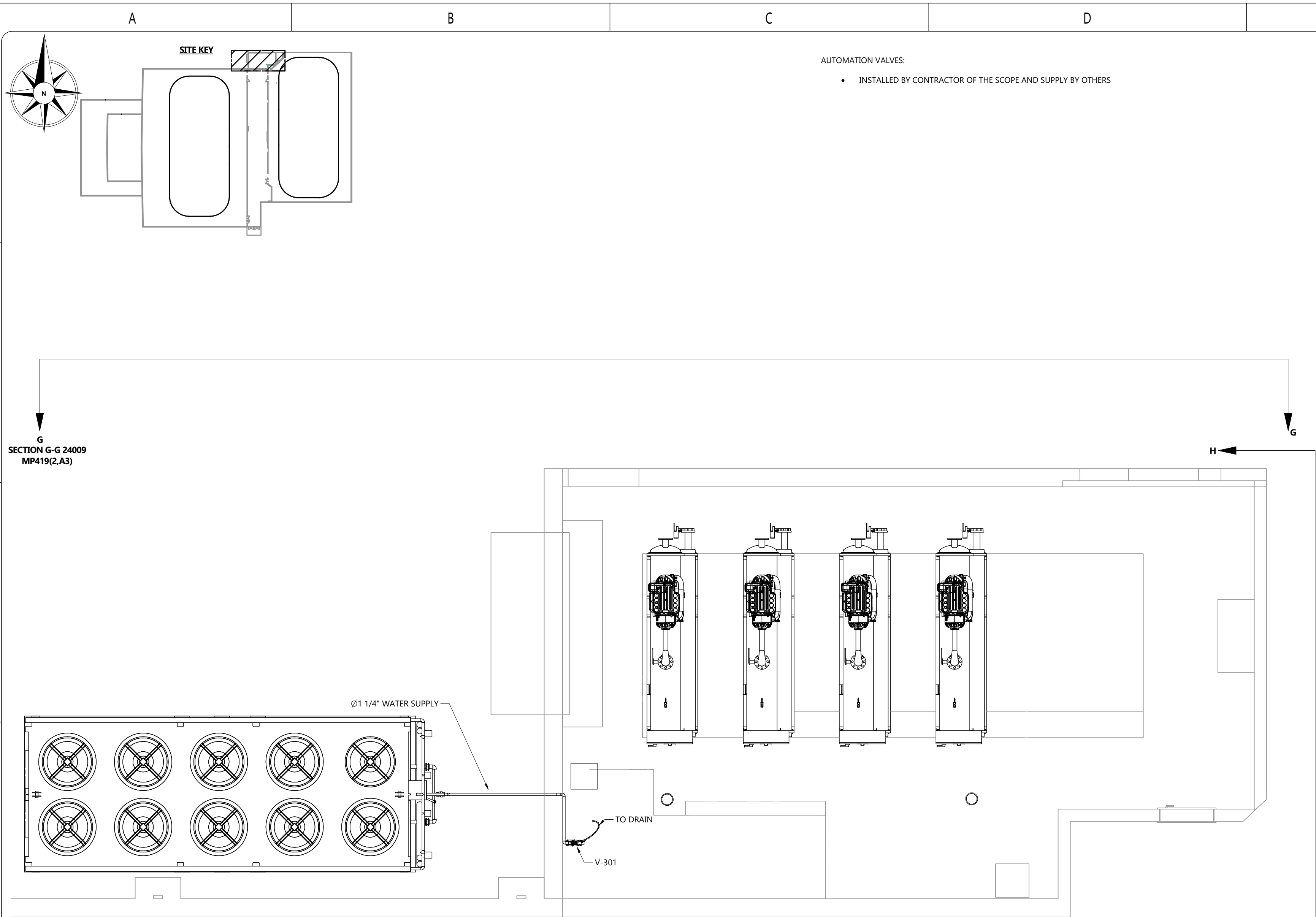

HEATING PIPING PLAN
SCALE 1/4" = 1'-0"

WATER PIPING PLAN

NOTES

REFERENCE DEFINITION	
SHEET COLUMN	SHEET ROW
SHEET NUMBER	(#, X#)

COPYRIGHT AND DISCLAIMER
THIS WORK IS THE SOLE PROPERTY OF I.B. STOREY INC AND IS INTENDED SOLELY FOR THE INFORMATION OF THE CLIENT. ALL RIGHTS RESERVED. THE WORK MAY NOT BE REPRODUCED OR DISTRIBUTED, WHOLE OR IN PART, WITHOUT THE PRIOR WRITTEN PERMISSION OF I.B. STOREY INC.
THIS DOCUMENT MAY NOT BE USED FOR ANY OTHER PROJECTS OR WITHOUT INVOLVEMENT OF I.B. STOREY INC. ANY USE WHICH A THIRD PARTY MAKES OF THE WORK, OR ANY RELIANCE ON OR DECISIONS TO BE MADE BASED ON IT, ARE THE RESPONSIBILITY OF SUCH THIRD PARTIES.

- NOT FOR CONSTRUCTION -
CONFIDENTIAL & PROPRIETARY

VER #	REVISIONS	DATE	BY
1.0	ISSUED FOR TENDER	21-NOV-24	H.D.



CHARLOTTETOWN PE
VAUGHAN ON
REDINGTON SHORES FL
PLANO, TX

WWW.IBSTOREY.COM

DRAWING NUMBER		24009 MP419	
DRAWING NAME		PLANT ROOM WARM PIPING LARGE-SCALE VIEW	
CLIENT		SPRINGFIELD PARK DISTRICT	
PROJECT		SPRINGFIELD-PLANT REPLACEMENT	
DRAWN BY	CHECKED BY		
H.DHAMELIYA	J.RITCHIE		
DATE	REVISION		
21-NOV-24	1.0		
SHEET SIZE	SHEET NO.		
C	1 OF 2		

24009 MP419

NOTES

REFERENCE DEFINITION	
SHEET COLUMN	SHEET ROW
(#, X#)	(#, X#)

COPYRIGHT AND DISCLAIMER
 THIS WORK IS THE SOLE PROPERTY OF I.B. STOREY INC AND IS INTENDED SOLELY FOR THE INFORMATION OF THE CLIENT. ALL RIGHTS RESERVED. THE WORK MAY NOT BE REPRODUCED OR DISTRIBUTED, WHOLE OR IN PART, WITHOUT THE PRIOR WRITTEN PERMISSION OF I.B. STOREY INC.
 THIS DOCUMENT MAY NOT BE USED FOR ANY OTHER PROJECTS OR WITHOUT INVOLVEMENT OF I.B. STOREY INC. ANY USE WHICH A THIRD PARTY MAKES OF THE WORK, OR ANY RELIANCE ON OR DECISIONS TO BE MADE BASED ON IT, ARE THE RESPONSIBILITY OF SUCH THIRD PARTIES.

- NOT FOR CONSTRUCTION -
 CONFIDENTIAL & PROPRIETARY

VER #	REVISIONS	DATE	BY
1.0	ISSUED FOR TENDER	21-NOV-24	H.D.



I.B. STOREY
 Rink Engineering Experts

CHARLOTTETOWN PE
 VAUGHAN ON
 REDINGTON SHORES FL
 PLANO, TX

WWW.IBSTOREY.COM

STAMP

DRAWING NUMBER 24009 MP419	
DRAWING NAME PLANT ROOM WARM PIPING LARGE-SCALE VIEW	
CLIENT SPRINGFIELD PARK DISTRICT	
PROJECT SPRINGFIELD-PLANT REPLACEMENT	
DRAWN BY H.DHAMELIYA	CHECKED BY J.RITCHIE
DATE 21-NOV-24	REVISION 1.0
SHEET SIZE C	SHEET NO. 2 OF 2

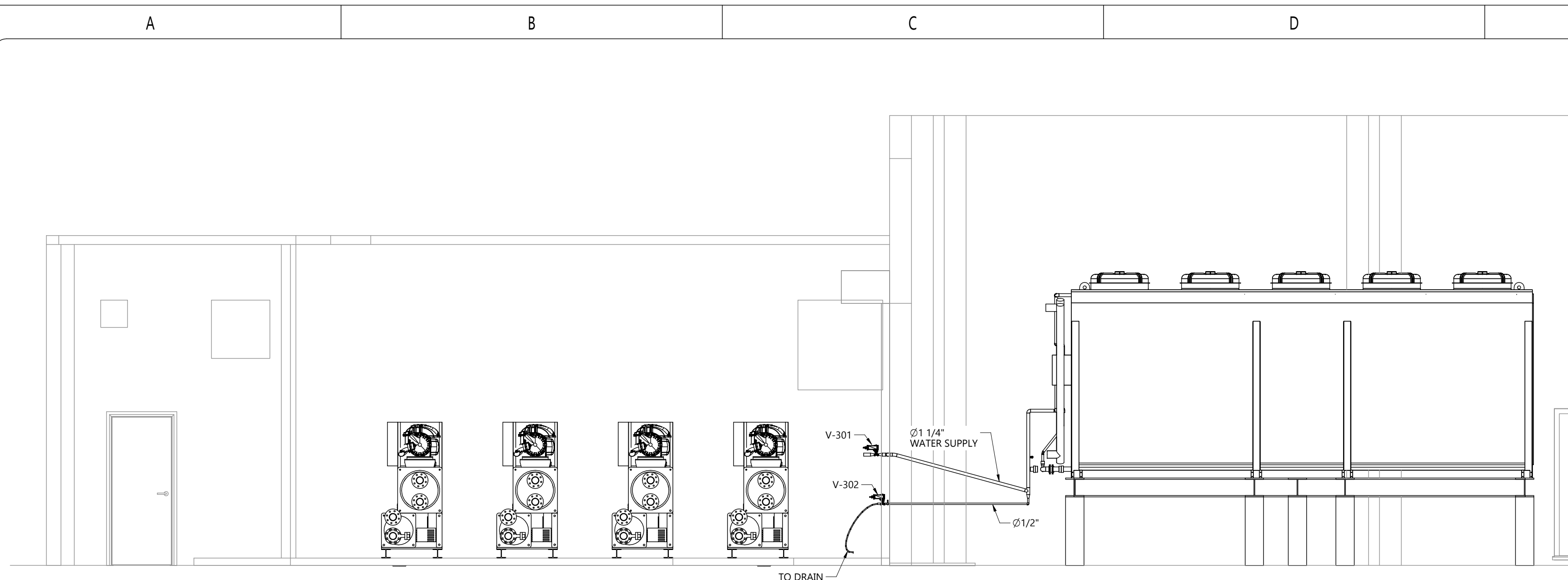

SECTION VIEW G-G180 (24009 MP419.1.A2)
 SCALE 1/4"=1'-0"

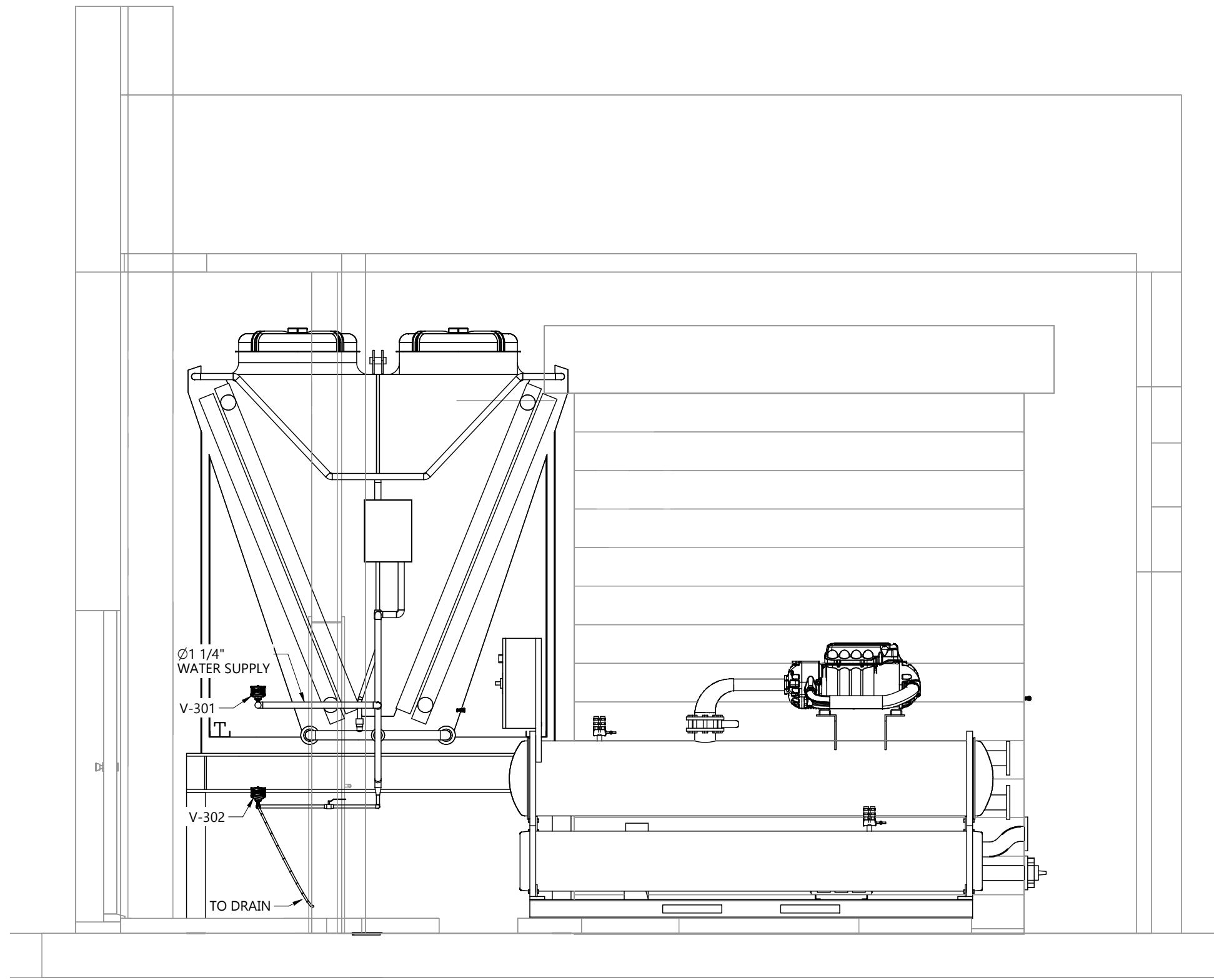

SECTION VIEW H-H 90 (24009 MP419.1.D5)
 SCALE 3/8"=1'-0"

WATER PIPING SECTION VIEWS

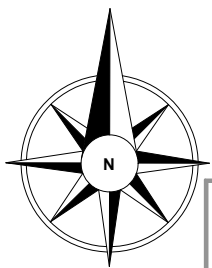

SITE KEY

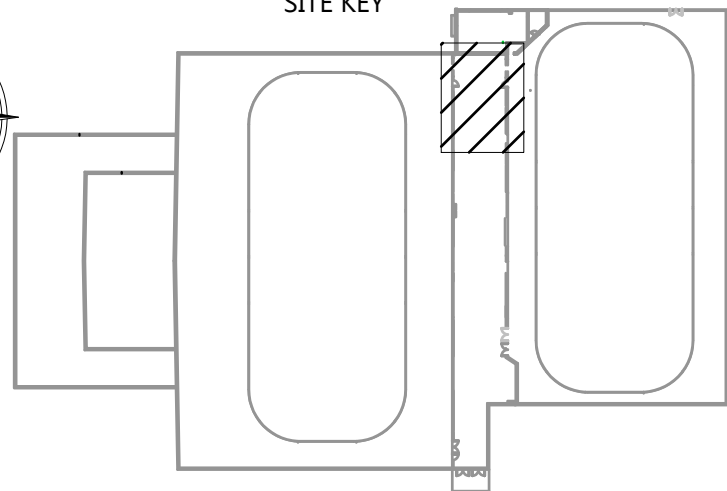

NOTE:
 • CONTRACTOR TO TEST EXISTING SNOW MELT PIT COIL FOR ANY LEAKS

NOTES

—	NEW
- - -	EXISTING

REFERENCE DEFINITION	
SHEET COLUMN	SHEET ROW
SHEET NUMBER	(#, X#)

COPYRIGHT AND DISCLAIMER
 THIS WORK IS THE SOLE PROPERTY OF I.B. STOREY INC AND IS INTENDED SOLELY FOR THE INFORMATION OF THE CLIENT. ALL RIGHTS RESERVED. THE WORK MAY NOT BE REPRODUCED OR DISTRIBUTED, WHOLE OR IN PART, WITHOUT THE PRIOR WRITTEN PERMISSION OF I.B. STOREY INC.
 THIS DOCUMENT MAY NOT BE USED FOR ANY OTHER PROJECTS OR WITHOUT INVOLVEMENT OF I.B. STOREY INC. ANY USE WHICH A THIRD PARTY MAKES OF THE WORK, OR ANY RELIANCE ON OR DECISIONS TO BE MADE BASED ON IT, ARE THE RESPONSIBILITY OF SUCH THIRD PARTIES.
- NOT FOR CONSTRUCTION -
CONFIDENTIAL & PROPRIETARY

1.0	ISSUED FOR TENDER	21-NOV-24	H.A.
VER #	REVISIONS	DATE	BY

CHARLOTTETOWN PE
 VAUGHAN ON
 REDINGTON SHORES FL
 PLANO TX
 WWW.IBSTOREY.COM

STAMP

DRAWING NUMBER		24009 MP421
DRAWING NAME		SNOW MELT PIT PIPING LARGE-SCALE VIEW
CLIENT		SPRINGFIELD PARK DISTRICT
PROJECT		SPRINGFIELD - PLANT REPLACEMENT
DRAWN BY	CHECKED BY	
H.AKAR	J. RITCHIE	
DATE	REVISION	
21-NOV-24	1.0	
SHEET SIZE	SHEET NO.	
C	1 OF 1	

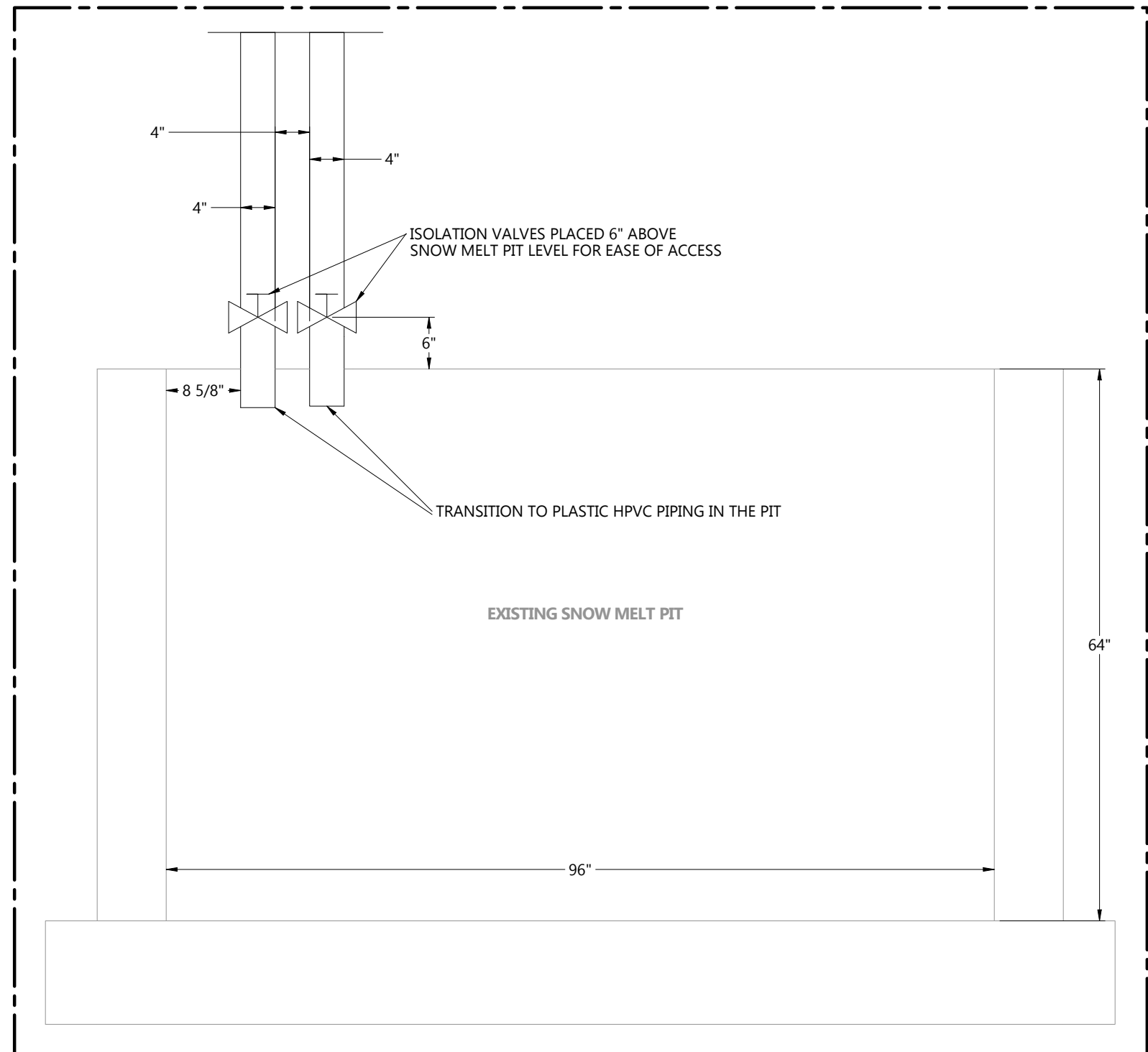

SECTION CUT L-L (1, D4): SNOW MELT PIT PIPING
 SCALE 3/4"=1'

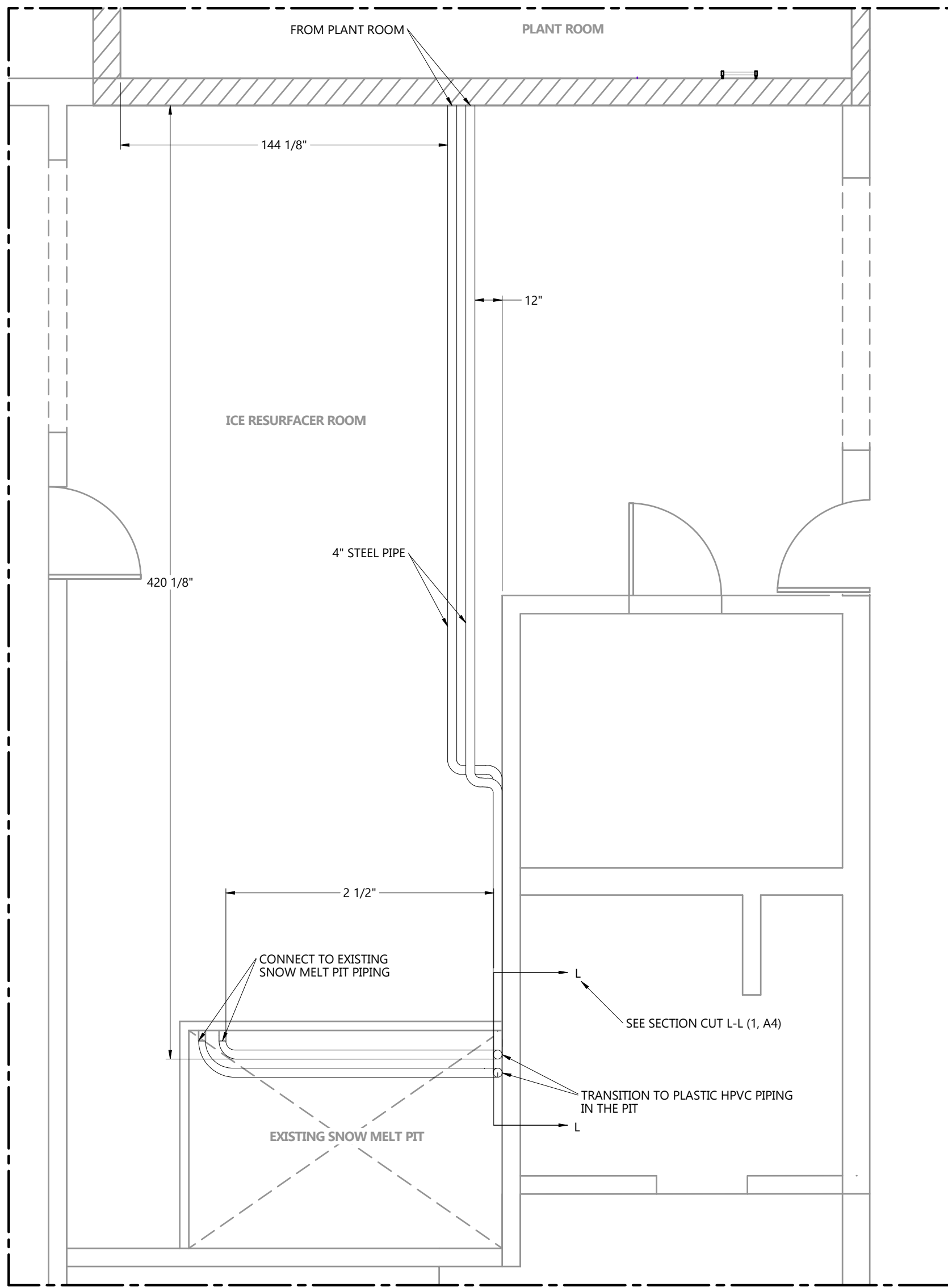

SNOW MELT PIT PIPING ENLARGED VIEW
 SCALE 1"=4'

SNOW MELT PIT PIPING ENLARGED VIEW

24009 MP421

1

2

3

4

5

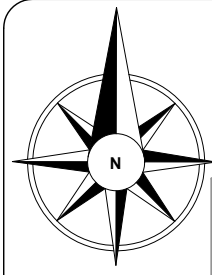

SITE KEY

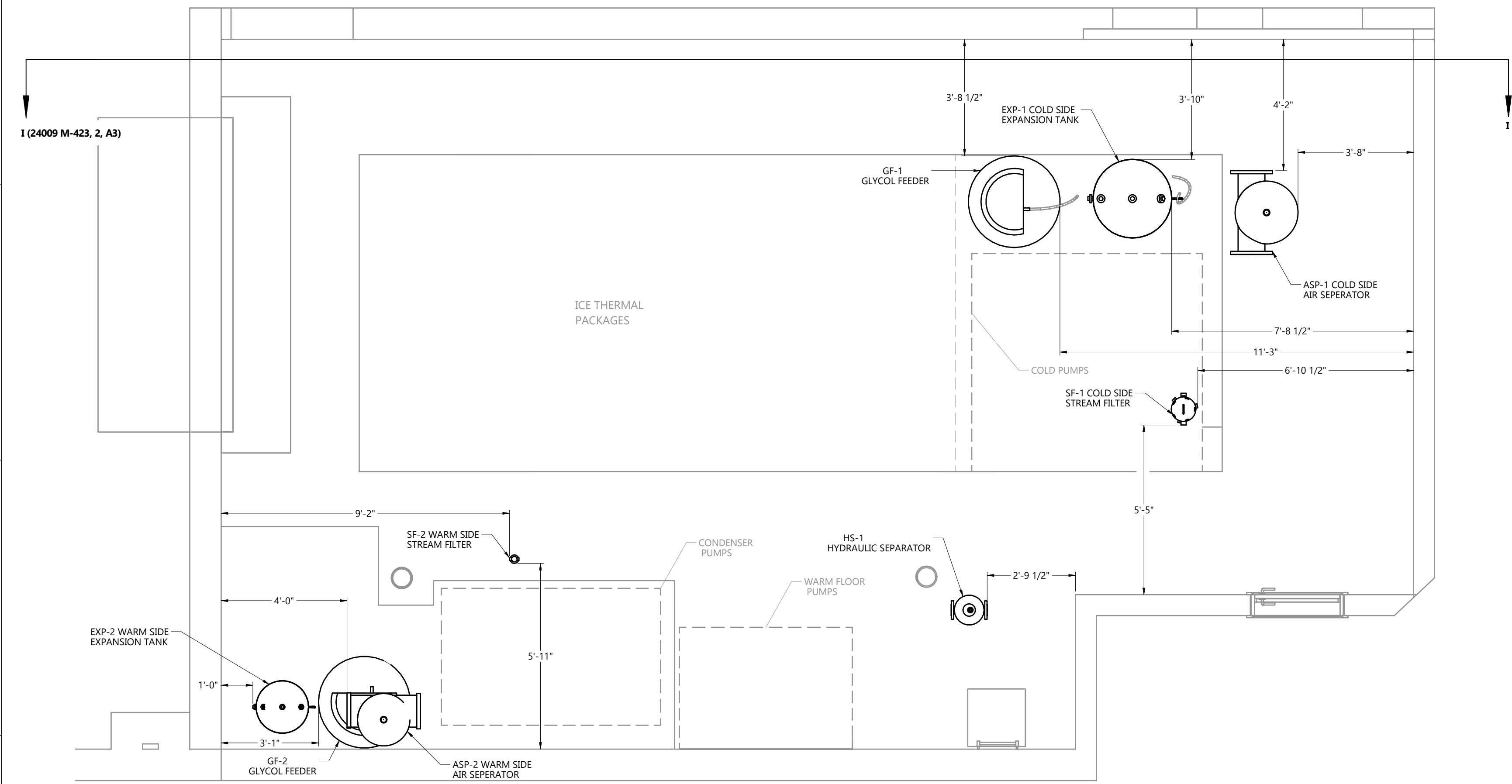

MISC. EQUIPMENT LAYOUT
SCALE 3/8"=1'-0"

MISC. EQUIPMENT TOP VIEW

NOTES

24009 MP423

REFERENCE DEFINITION	
SHEET COLUMN	SHEET ROW
(#, X#)	

COPYRIGHT AND DISCLAIMER
THIS WORK IS THE SOLE PROPERTY OF I.B. STOREY INC AND IS INTENDED SOLELY FOR THE INFORMATION OF THE CLIENT. ALL RIGHTS RESERVED. THE WORK MAY NOT BE REPRODUCED OR DISTRIBUTED, WHOLE OR IN PART, WITHOUT THE PRIOR WRITTEN PERMISSION OF I.B. STOREY INC.
THIS DOCUMENT MAY NOT BE USED FOR ANY OTHER PROJECTS OR WITHOUT INVOLVEMENT OF I.B. STOREY INC. ANY USE WHICH A THIRD PARTY MAKES OF THE WORK, OR ANY RELIANCE ON OR DECISIONS TO BE MADE BASED ON IT, ARE THE RESPONSIBILITY OF SUCH THIRD PARTIES.

- NOT FOR CONSTRUCTION -
CONFIDENTIAL & PROPRIETARY

VER #	ISSUED FOR TENDER	DATE	V.K.
1.0	ISSUED FOR TENDER	21-NOV-24	V.K.
VER #	REVISIONS	DATE	BY



CHARLOTTETOWN PE
VAUGHAN ON
REDINGTON SHORES FL
PLANO, TX

WWW.IBSTOREY.COM

DRAWING NUMBER	
24009 MP423	
DRAWING NAME	
PLANT ROOM MISC. EQUIPMENT LARGE-SCALE VIEWS	
CLIENT	
SPRINGFIELD PARK DISTRICT	
PROJECT	
SPRINGFIELD-PLANT REPLACEMENT	
DRAWN BY	CHECKED BY
V.KOFANOV	J.RITCHIE
DATE	REVISION
21-NOV-24	1.0
SHEET SIZE	SHEET NO.
C	1 OF 2

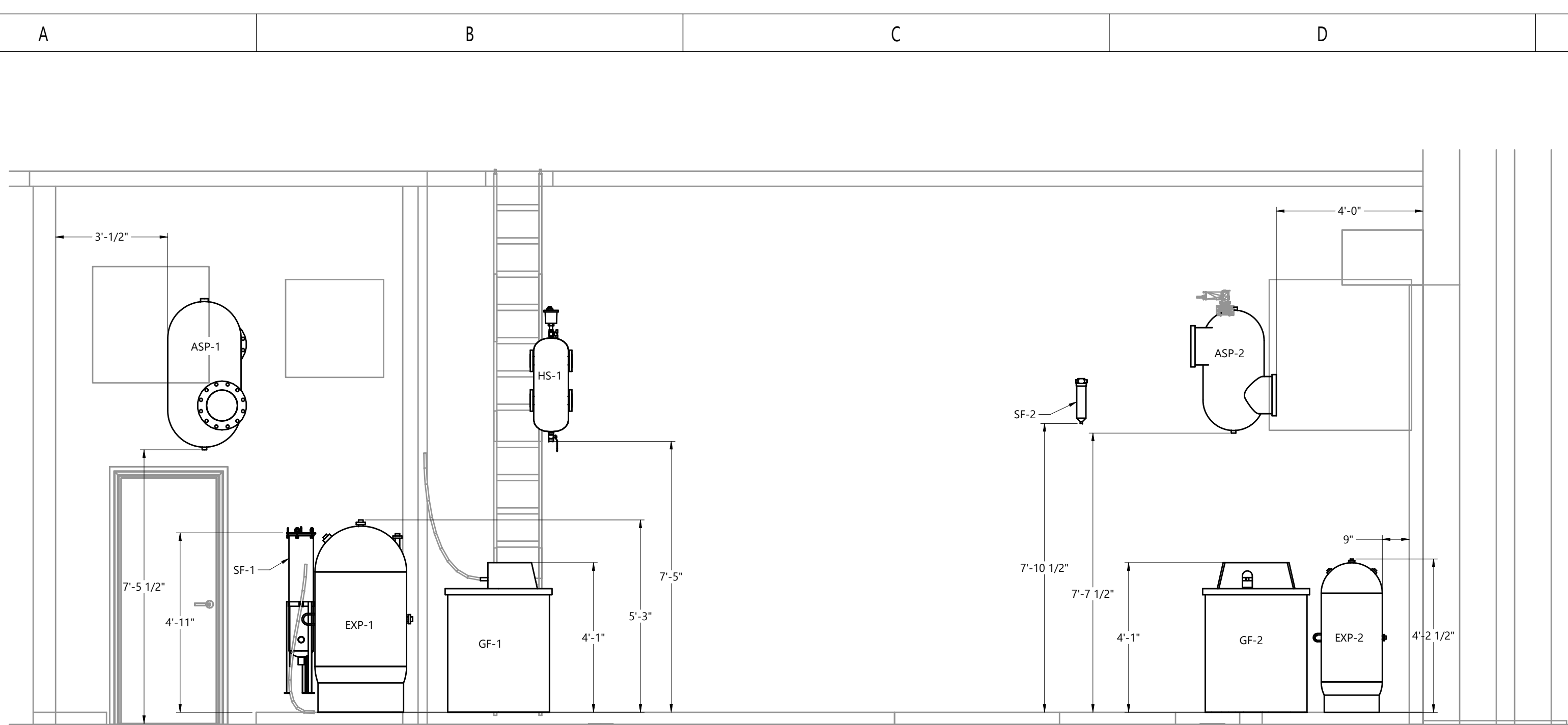

SECTION CUT I-I (24009 M-423, 1, A2)
SCALE 3/8"=1'-0"

IB.STOREY DESIGN STANDARDS SCHEDULE

TAG	DESCRIPTION	QTY.	SERVICE/LOCATION ID	MAX.FLOW, USGPM	MANUFACTURER AND MODEL NO.	ACCEPTANCE VOLUME, USGAL	VOLUME, USGAL	SHIPPING WEIGHT, LB
EX-1	EXP. TANK	1	COLD SIDE	-	ARMSTRONG AX-260V	128	158	812
EX-2	EXP. TANK	1	WARM SIDE	-	ARMSTRONG AX-100V	48.5	60	218
AS-1	AIR SEPARATOR	1	COLD SIDE	1868	VASAME VA-10-U	-	-	390
AS-2	AIR SEPARATOR	1	WARM SIDE	880	VASAME VA-8-U	-	-	228
GF-1	FEEDER	1	COLD SIDE	-	AXIOM SF-100L	-	100	55
GF-2	FEEDER	1	WARM SIDE	-	AXIOM SF-100L	-	100	55

WARM FLOOR HYDRAULIC SEPARATOR SCHEDULE

TAG	FLUID	QTY.	SIZE IN	CAPACITY, GPM	MANUFACTURER AND MODEL NO.
HS-1	40% E. GLYCOL	1	2.5	80	CALEFFI 548062A

SIDE STREAM FILTER SCHEDULE

TAG	MODEL	SIZE	SIDE STREAM FLOW RATE	FILTER SIZE	VESSEL VOLUME
SF-1	PRM BFH8FH2DCSX	2"	100 GPM	POLYESTER FELT BAG #2 7-1/16" DIA X 32"L	-
SF-2	SFP-20	1"	10-20 GPM	20" DOE COTTON WOUND	0.8 GAL

MISC. EQUIPMENT SECTION VIEWS

NOTES

REFERENCE DEFINITION	
SHEET COLUMN	SHEET ROW
SHEET NUMBER	(#, X#)

COPYRIGHT AND DISCLAIMER
THIS WORK IS THE SOLE PROPERTY OF I.B. STOREY INC AND IS INTENDED SOLELY FOR THE INFORMATION OF THE CLIENT. ALL RIGHTS RESERVED. THE WORK MAY NOT BE REPRODUCED OR DISTRIBUTED, WHOLE OR IN PART, WITHOUT THE PRIOR WRITTEN PERMISSION OF I.B. STOREY INC.
THIS DOCUMENT MAY NOT BE USED FOR ANY OTHER PROJECTS OR WITHOUT INVOLVEMENT OF I.B. STOREY INC. ANY USE WHICH A THIRD PARTY MAKES OF THE WORK, OR ANY RELIANCE ON OR DECISIONS TO BE MADE BASED ON IT, ARE THE RESPONSIBILITY OF SUCH THIRD PARTIES.

- NOT FOR CONSTRUCTION -
CONFIDENTIAL & PROPRIETARY

VER #	REVISIONS	DATE	BY
1.0	ISSUED FOR TENDER	21-NOV-24	V.K.



CHARLOTTETOWN PE
VAUGHAN ON
REDINGTON SHORES FL
PLANO, TX

WWW.IBSTOREY.COM

STAMP

DRAWING NUMBER		24009 MP423	
DRAWING NAME		PLANT ROOM MISC. EQUIPMENT LARGE-SCALE VIEWS	
CLIENT			
SPRINGFIELD PARK DISTRICT			
PROJECT			
SPRINGFIELD-PLANT REPLACEMENT			
DRAWN BY	CHECKED BY		
V.KOFANOV	J.RITCHIE		
DATE	REVISION		
21-NOV-24	1.0		
SHEET SIZE	SHEET NO.		
C	2 OF 2		

24009 MP423

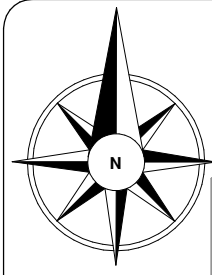

SITE KEY

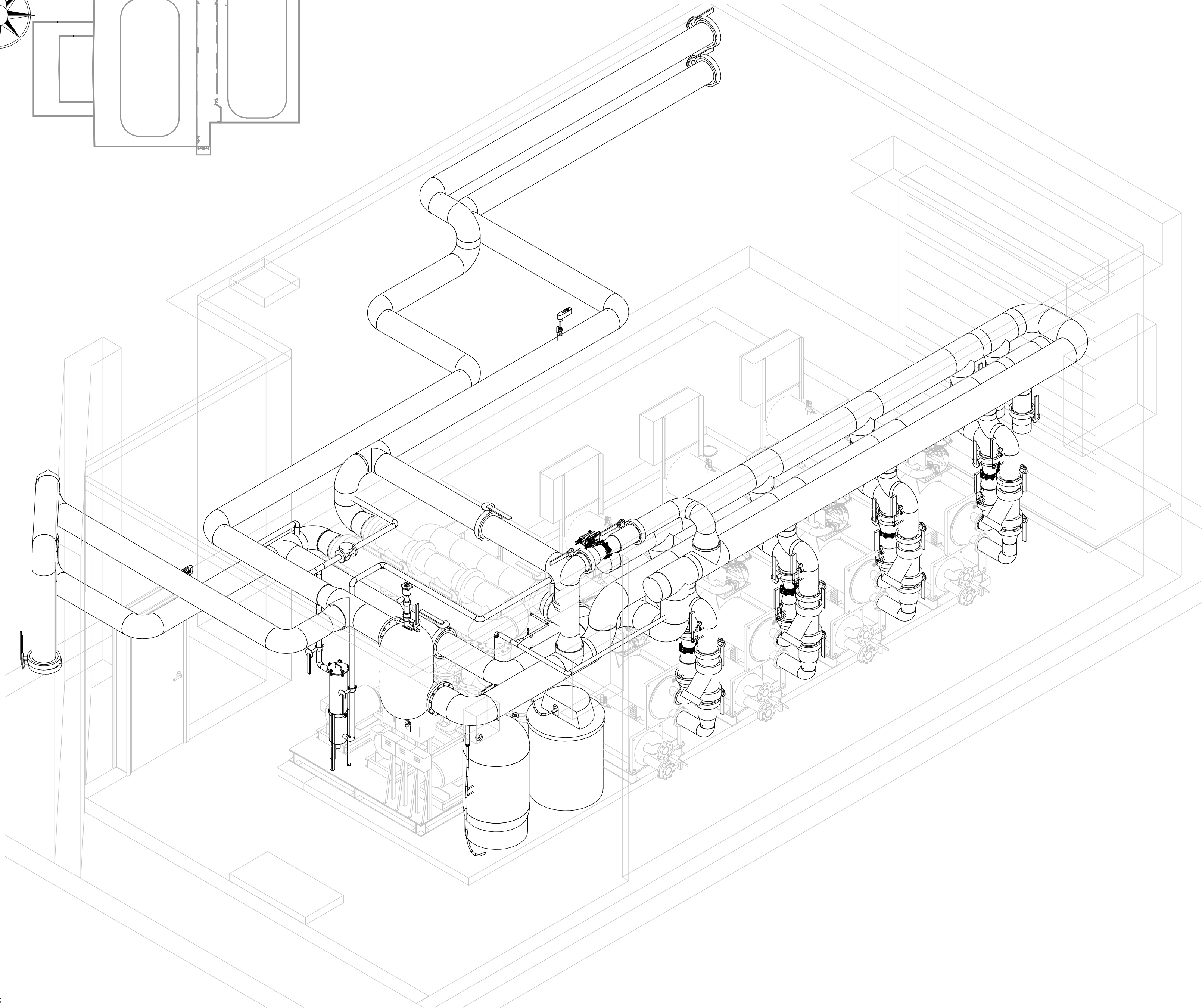
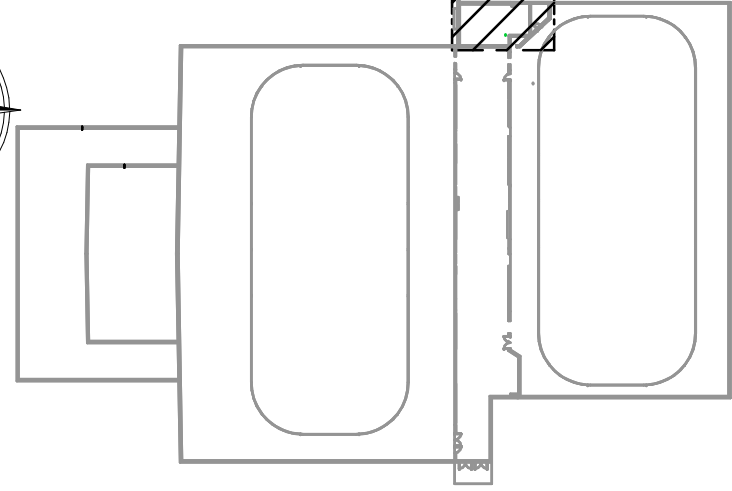

ISOMETRIC VIEW
SCALE 3/8" = 1'-0"

COOLING PIPING ISOMETRIC VIEW

NOTES:

- AFC HIDDEN FOR CLARITY.
- ALL EXHAUST FANS AND INTAKE LOUVERS ARE HIDDEN FOR CLARITY.
- EQUIPMENTS NOT ASSOCIATED WITH COOLING PIPING HIDDEN FOR CLARITY.

NOTES

—	NEW
—	EXISTING

REFERENCE DEFINITION	
SHEET COLUMN	SHEET ROW
SHEET NUMBER	(#, X#)

COPYRIGHT AND DISCLAIMER
THIS WORK IS THE SOLE PROPERTY OF I.B. STOREY INC AND IS INTENDED SOLELY FOR THE INFORMATION OF THE CLIENT. ALL RIGHTS RESERVED. THE WORK MAY NOT BE REPRODUCED OR DISTRIBUTED, WHOLE OR IN PART, WITHOUT THE PRIOR WRITTEN PERMISSION OF I.B. STOREY INC.
THIS DOCUMENT MAY NOT BE USED FOR ANY OTHER PROJECTS OR WITHOUT INVOLVEMENT OF I.B. STOREY INC. ANY USE WHICH A THIRD PARTY MAKES OF THE WORK, OR ANY RELIANCE ON OR DECISIONS TO BE MADE BASED ON IT, ARE THE RESPONSIBILITY OF SUCH THIRD PARTIES.

- NOT FOR CONSTRUCTION -
CONFIDENTIAL & PROPRIETARY

1.0	ISSUED FOR TENDER	21-NOV-24	R.T.
VER #	REVISIONS	DATE	BY



CHARLOTTETOWN PE
VAUGHAN ON
REDINGTON SHORES FL
PLANO, TX

WWW.IBSTOREY.COM

STAMP

DRAWING NUMBER 24009 MP911	
DRAWING NAME COOLING PIPING ISOMETRIC VIEW	
CLIENT SPRINGFIELD PARK DISTRICT	
PROJECT SPRINGFIELD-PLANT REPLACEMENT	
DRAWN BY R.THOMAS	CHECKED BY J.RITCHIE
DATE 21-NOV-24	REVISION 1.0
SHEET SIZE C	SHEET NO. 1 OF 1

24009 MP911

1

2

3

4

5

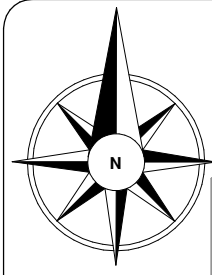

SITE KEY

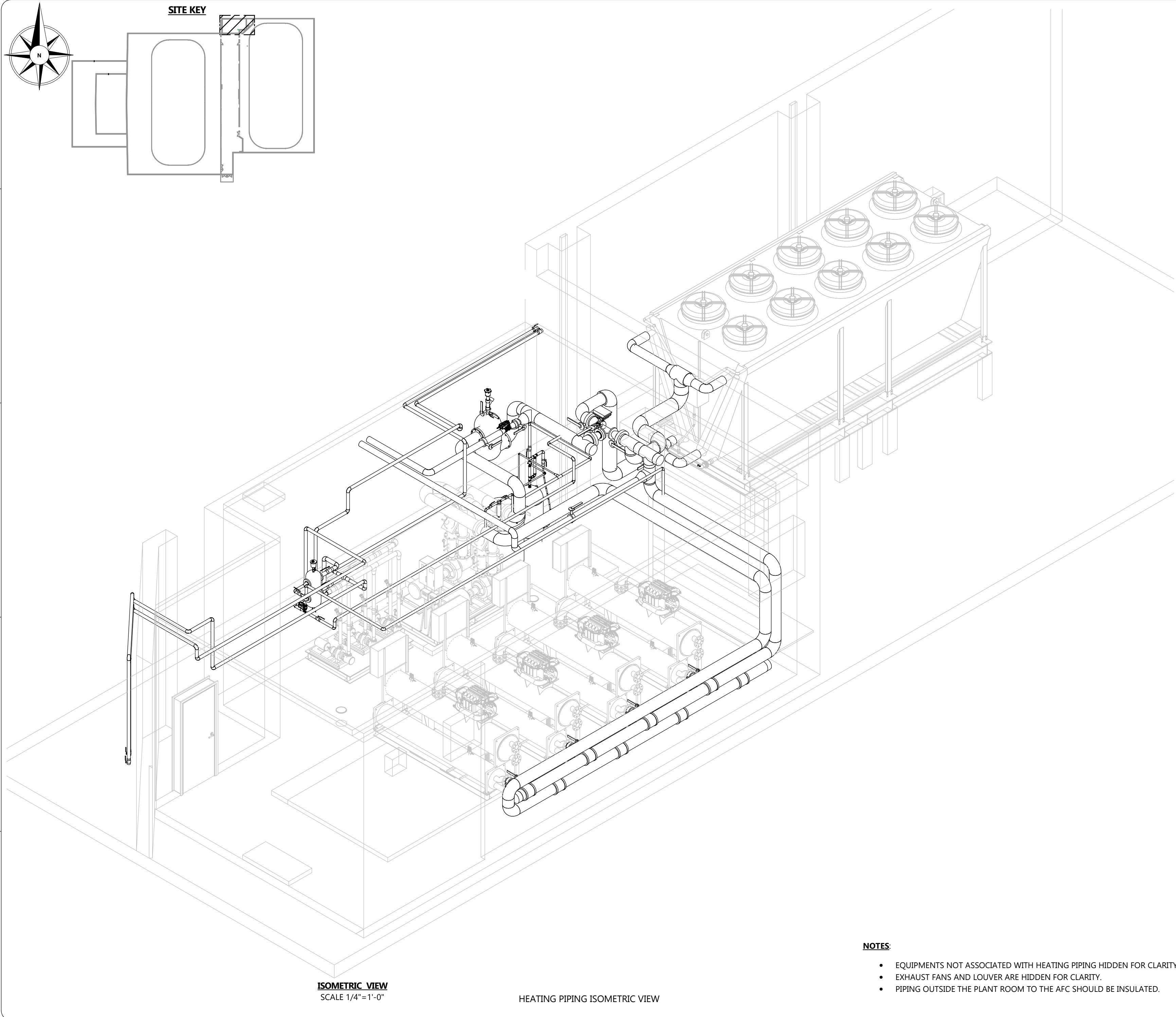
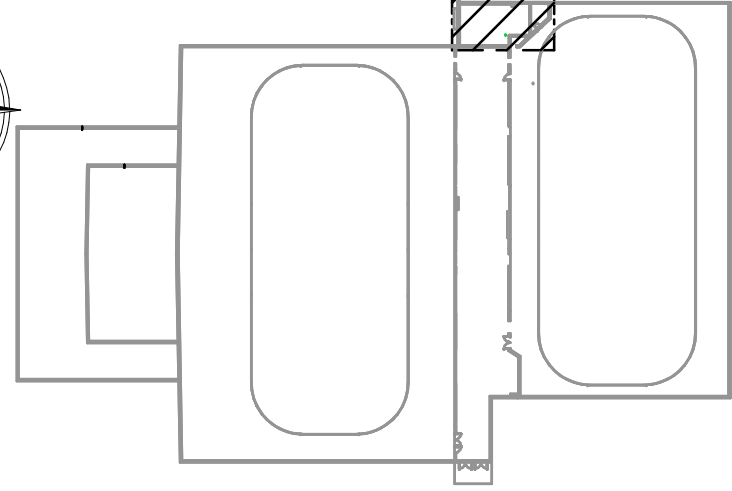

ISOMETRIC VIEW
SCALE 1/4"=1'-0"

HEATING PIPING ISOMETRIC VIEW

NOTES:

- EQUIPMENTS NOT ASSOCIATED WITH HEATING PIPING HIDDEN FOR CLARITY.
- EXHAUST FANS AND LOUVER ARE HIDDEN FOR CLARITY.
- PIPING OUTSIDE THE PLANT ROOM TO THE AFC SHOULD BE INSULATED.

NOTES

REFERENCE DEFINITION	
SHEET COLUMN	SHEET ROW
SHEET NUMBER	(#, X#)

COPYRIGHT AND DISCLAIMER
THIS WORK IS THE SOLE PROPERTY OF I.B. STOREY INC AND IS INTENDED SOLELY FOR THE INFORMATION OF THE CLIENT. ALL RIGHTS RESERVED. THE WORK MAY NOT BE REPRODUCED OR DISTRIBUTED, WHOLE OR IN PART, WITHOUT THE PRIOR WRITTEN PERMISSION OF I.B. STOREY INC.
THIS DOCUMENT MAY NOT BE USED FOR ANY OTHER PROJECTS OR WITHOUT INVOLVEMENT OF I.B. STOREY INC. ANY USE WHICH A THIRD PARTY MAKES OF THE WORK, OR ANY RELIANCE ON OR DECISIONS TO BE MADE BASED ON IT, ARE THE RESPONSIBILITY OF SUCH THIRD PARTIES.

- NOT FOR CONSTRUCTION -
CONFIDENTIAL & PROPRIETARY

VER #	REVISIONS	DATE	BY
1.0	ISSUED FOR TENDER	21-NOV-24	R.T.



CHARLOTTETOWN PE
VAUGHAN ON
REDINGTON SHORES FL
PLANO, TX

WWW.IBSTOREY.COM

STAMP

DRAWING NUMBER	
24009 MP913	
DRAWING NAME	
HEATING PIPING ISOMETRIC VIEW	
CLIENT	
SPRINGFIELD PARK DISTRICT	
PROJECT	
SPRINGFIELD-PLANT REPLACEMENT	
DRAWN BY	CHECKED BY
R.THOMAS	J.RITCHIE
DATE	REVISION
21-NOV-24	1.0
SHEET SIZE	SHEET NO.
C	1 OF 1

24009 MP913

1

2

3

4

5

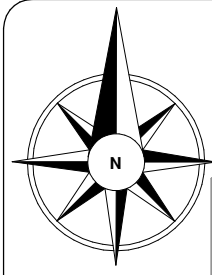

SITE KEY

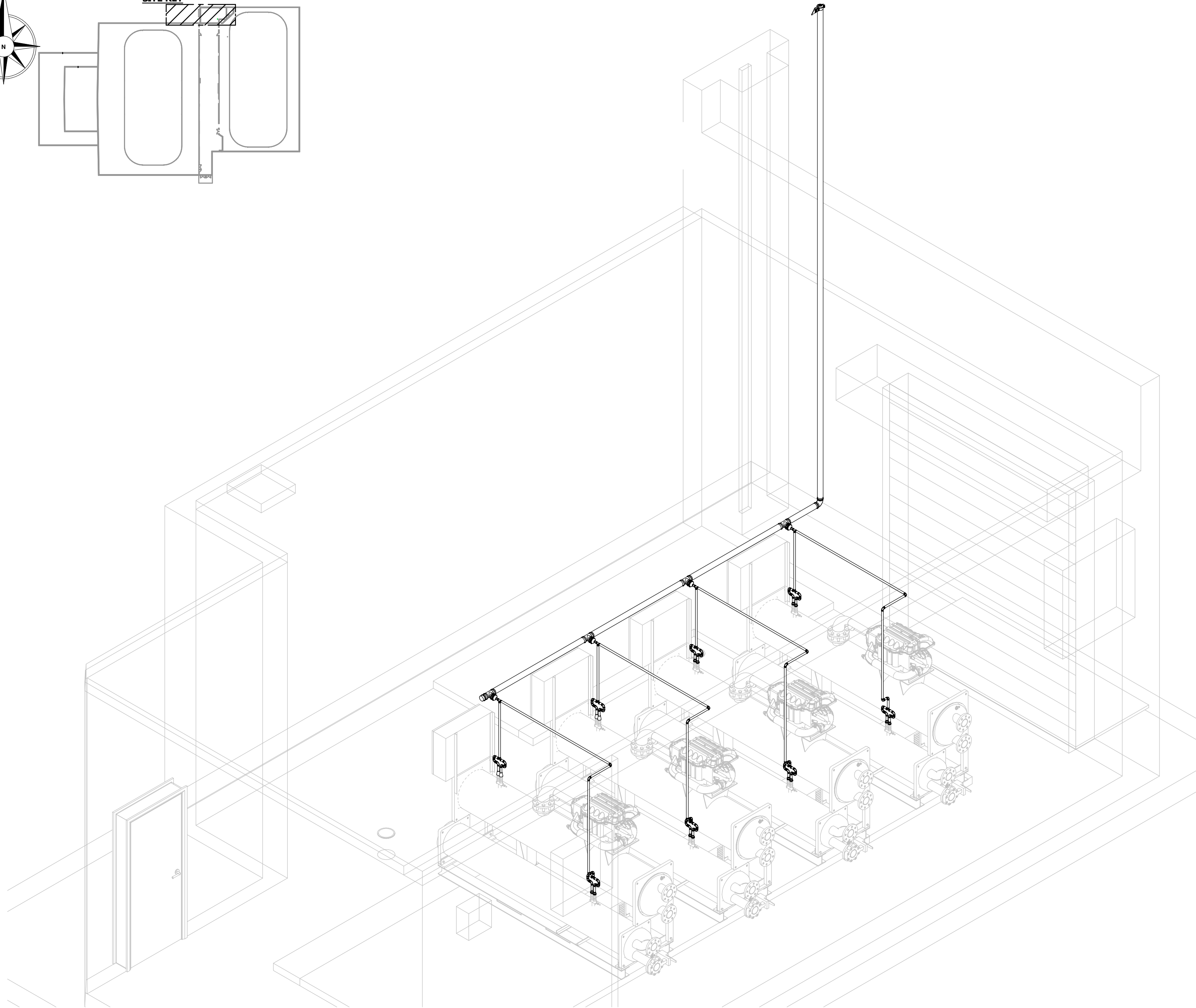
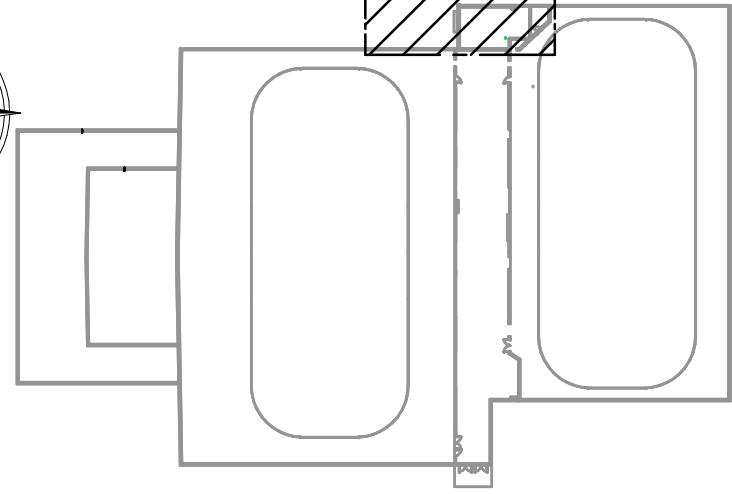

ISOMETRIC VIEW
SCALE 3/8"=1'-0"

RELIEF PIPING ISOMETRIC VIEW

NOTES:

- AFC HIDDEN FOR CLARITY.
- EQUIPMENTS NOT ASSOCIATED WITH RELIEF PIPING HIDDEN FOR CLARITY.
- EXHAUST FANS AND LOUVER ARE HIDDEN FOR CLARITY.

NOTES

REFERENCE DEFINITION	
SHEET COLUMN	SHEET ROW
SHEET NUMBER	(#, X#)

COPYRIGHT AND DISCLAIMER
 THIS WORK IS THE SOLE PROPERTY OF I.B. STOREY INC AND IS INTENDED SOLELY FOR THE INFORMATION OF THE CLIENT. ALL RIGHTS RESERVED. THE WORK MAY NOT BE REPRODUCED OR DISTRIBUTED, WHOLE OR IN PART, WITHOUT THE PRIOR WRITTEN PERMISSION OF I.B. STOREY INC.
 THIS DOCUMENT MAY NOT BE USED FOR ANY OTHER PROJECTS OR WITHOUT INVOLVEMENT OF I.B. STOREY INC. ANY USE WHICH A THIRD PARTY MAKES OF THE WORK, OR ANY RELIANCE ON OR DECISIONS TO BE MADE BASED ON IT, ARE THE RESPONSIBILITY OF SUCH THIRD PARTIES.

- NOT FOR CONSTRUCTION -
CONFIDENTIAL & PROPRIETARY

VER #	REVISIONS	DATE	BY
1.0	ISSUED FOR TENDER	21-NOV-24	R.T.



CHARLOTTETOWN PE
 VAUGHAN ON
 REDINGTON SHORES FL
 PLANO, TX

WWW.IBSTOREY.COM

STAMP

DRAWING NUMBER 24009 MP915	
DRAWING NAME RELIEF PIPING ISOMETRIC VIEW	
CLIENT SPRINGFIELD PARK DISTRICT	
PROJECT SPRINGFIELD-PLANT REPLACEMENT	
DRAWN BY R.THOMAS	CHECKED BY J.RITCHIE
DATE 21-NOV-24	REVISION 1.0
SHEET SIZE C	SHEET NO. 1 OF 1

24009 MP915

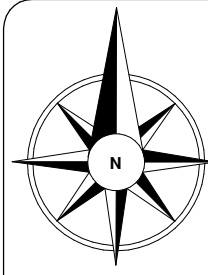

SITE KEY

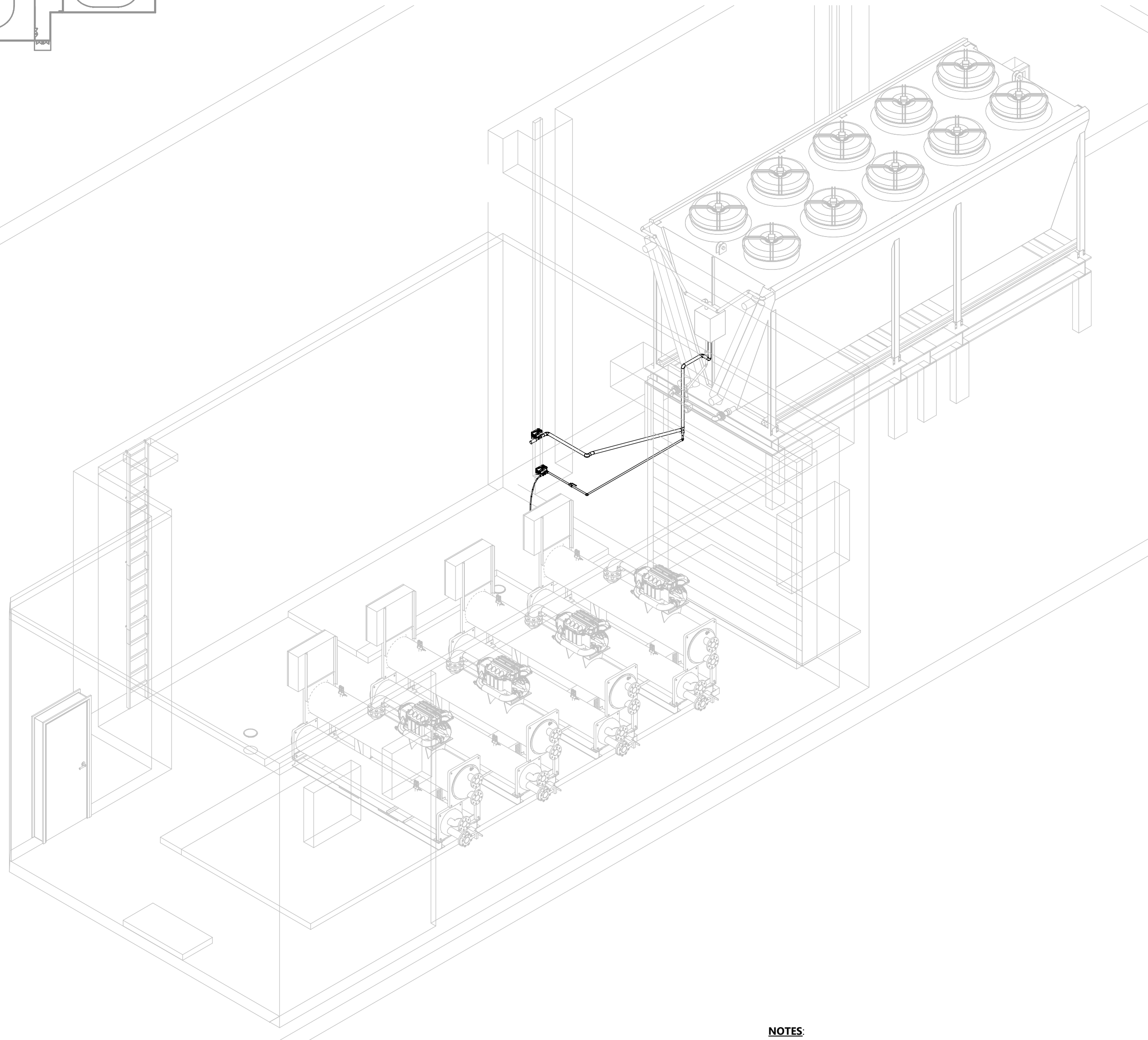
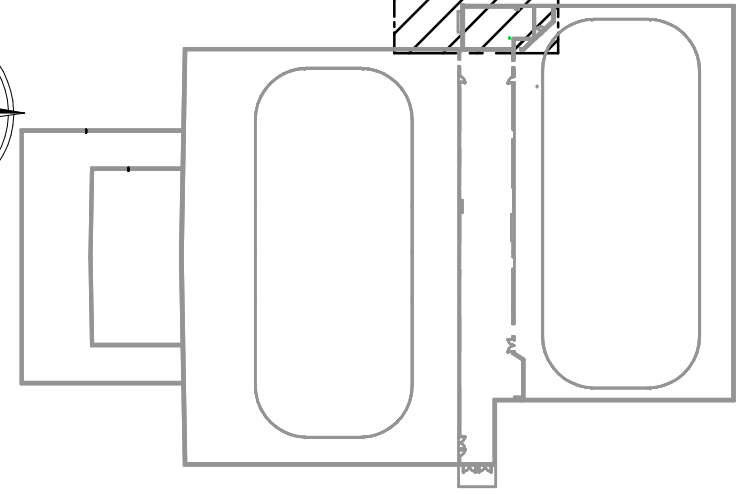

ISOMETRIC VIEW
SCALE 1/4"=1'-0"

WATER PIPING ISOMETRIC VIEW

NOTES:

- EQUIPMENTS NOT ASSOCIATED WITH DOMESTIC COLD WATER PIPING HIDDEN FOR CLARITY.
- EXHAUST FANS AND LOUVER ARE HIDDEN FOR CLARITY.
- PUMP SKIDS HIDDEN FOR CLARITY.

NOTES

REFERENCE DEFINITION	
SHEET COLUMN	SHEET ROW
SHEET NUMBER	(#, X#)

COPYRIGHT AND DISCLAIMER
THIS WORK IS THE SOLE PROPERTY OF I.B. STOREY INC AND IS INTENDED SOLELY FOR THE INFORMATION OF THE CLIENT. ALL RIGHTS RESERVED. THE WORK MAY NOT BE REPRODUCED OR DISTRIBUTED, WHOLE OR IN PART, WITHOUT THE PRIOR WRITTEN PERMISSION OF I.B. STOREY INC.
THIS DOCUMENT MAY NOT BE USED FOR ANY OTHER PROJECTS OR WITHOUT INVOLVEMENT OF I.B. STOREY INC. ANY USE WHICH A THIRD PARTY MAKES OF THE WORK, OR ANY RELIANCE ON OR DECISIONS TO BE MADE BASED ON IT, ARE THE RESPONSIBILITY OF SUCH THIRD PARTIES.

- NOT FOR CONSTRUCTION -
CONFIDENTIAL & PROPRIETARY

VER #	REVISIONS	DATE	BY
1.0	ISSUED FOR TENDER	21-NOV-24	R.T.



CHARLOTTETOWN PE
VAUGHAN ON
REDINGTON SHORES FL
PLANO, TX

WWW.IBSTOREY.COM

STAMP

DRAWING NUMBER 24009 MP917	
DRAWING NAME WATER PIPING ISOMETRIC VIEW	
CLIENT SPRINGFIELD PARK DISTRICT	
PROJECT SPRINGFIELD-PLANT REPLACEMENT	
DRAWN BY R.THOMAS	CHECKED BY J.RITCHIE
DATE 21-NOV-24	REVISION 1.0
SHEET SIZE C	SHEET NO. 1 OF 1

24009 MP917

NOTE:
THIS STANDARD WAS ESTABLISHED TO PROVIDE ADDITIONAL INSIGHTS ON PIPING, CONNECTIONS, MODEL DESIGNATIONS, AND SIMILAR ASPECTS. REFER TO THE DASH NUMBER INDICATED ON THE P&ID FOR THE REQUISITE MODEL IDENTIFICATIONS OF THE RELIEF VALVE. ONLY EMPLOY THE MODEL ASSOCIATED WITH THE DASH NUMBER DELINEATED ON THE P&ID.

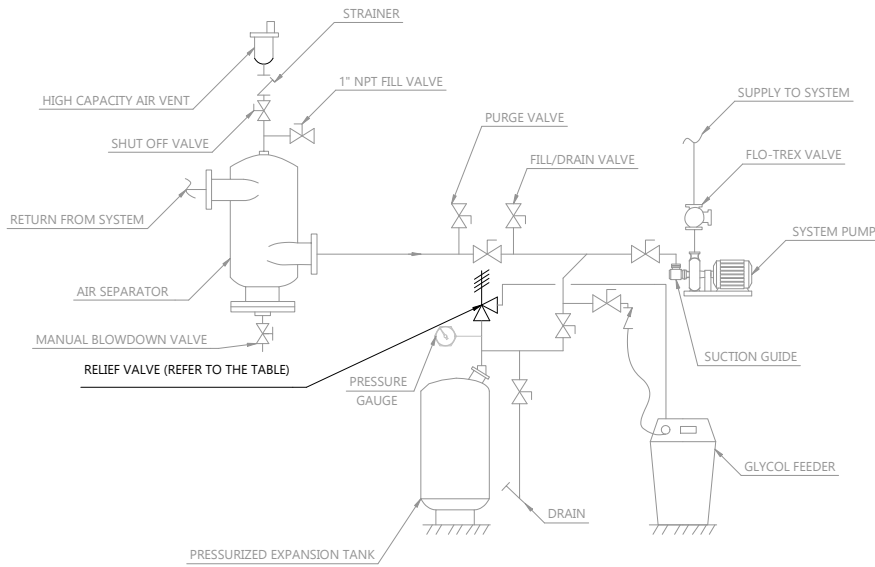

**RELIEF VALVE TYPICAL CONNECTIONS
(WARM GLYCOL LOOP)**

GLYCOL RELIEF VALVE SCHEDULE					
DASH NUMBER	MODEL NUMBER	MANUFACTURER	PRESSURE RANGE, PSI	MBH, RANGE	MAX. TEMP., F
-01	174A	WATTS	30 - 150	650 - 14,370	250
-02	374A	WATTS	30	UP TO 550	-
-03	740	WATTS	30 - 75	925 - 10,700	250

MANUFACTURER INSTALL NOTES:

- THE DISCHARGE LINE MUST BE THE SAME SIZE AS THE VALVE OUTLET, AND MUST PITCH DOWNWARD FROM THE VALVE TO A SAFE PLACE FOR DISPOSAL.
- VALVE LEVER MUST BE TRIPPED AT LEAST ONCE A YEAR TO ENSURE THAT WATERWAYS ARE CLEAR. THIS DEVICE IS DESIGNED FOR EMERGENCY SAFETY RELIEF AND SHALL NOT BE USED AS AN OPERATING CONTROL.

GLYCOL SYSTEM RELIEF VALVES

	SHUT-OFF VALVE
	MANUAL VALVE
	CHECK VALVE
	RELIEF VALVE
	AIR VENT
	MANUAL DRAIN

— NEW EQUIPMENT

COPYRIGHT AND DISCLAIMER
THIS WORK IS THE SOLE PROPERTY OF I.B. STOREY INC AND IS INTENDED SOLELY FOR THE INFORMATION OF THE CLIENT. ALL RIGHTS RESERVED. THE WORK MAY NOT BE REPRODUCED OR DISTRIBUTED, WHOLE OR IN PART, WITHOUT THE PRIOR WRITTEN PERMISSION OF I.B. STOREY INC.
THIS DOCUMENT MAY NOT BE USED FOR ANY OTHER PROJECTS OR WITHOUT INVOLVEMENT OF I.B. STOREY INC. ANY USE WHICH A THIRD PARTY MAKES OF THE WORK, OR ANY RELIANCE ON OR DECISIONS TO BE MADE BASED ON IT, ARE THE RESPONSIBILITY OF SUCH THIRD PARTIES.

FOR ILLUSTRATION ONLY

**- NOT FOR CONSTRUCTION -
CONFIDENTIAL & PROPRIETARY**

10.0	30-AUG-24	H.A.
9.0	25-MAR-24	E.K.
8.0	15-JUN-23	T.V.W.
VER #	DATE	BY

I.B. STOREY
Rink Engineering Experts
CHARLOTTETOWN PE
VAUGHAN ON
REDINGTON SHORES FL
PLANO TX
WWW.IBSTOREY.COM

STAMP

DRAWING NUMBER		IBSDS M-801	
DRAWING NAME		GLYCOL RELIEF VALVE DESIGN STANDARD	
CLIENT		I.B. STOREY INC.	
PROJECT		IB STOREY DESIGN STANDARDS	
DRAWN BY	E.KADYROVA	CHECKED BY	J.RITCHIE
DATE	30-AUG-24	REVISION	10.0
SHEET SIZE	A	SHEET NO.	1 OF 1

NOTE:
 - THIS STANDARD WAS ESTABLISHED TO PROVIDE ADDITIONAL INSIGHTS ON PIPING, CONNECTIONS, MODEL DESIGNATIONS, AND SIMILAR ASPECTS.
 - REFER TO THE DASH NUMBER INDICATED ON THE P&ID FOR THE REQUISITE MODEL IDENTIFICATIONS OF THE AIR SEPARATOR AND AIR VENT.
 - ONLY EMPLOY THE MODEL ASSOCIATED WITH THE DASH NUMBER DELINEATED ON THE P&ID.

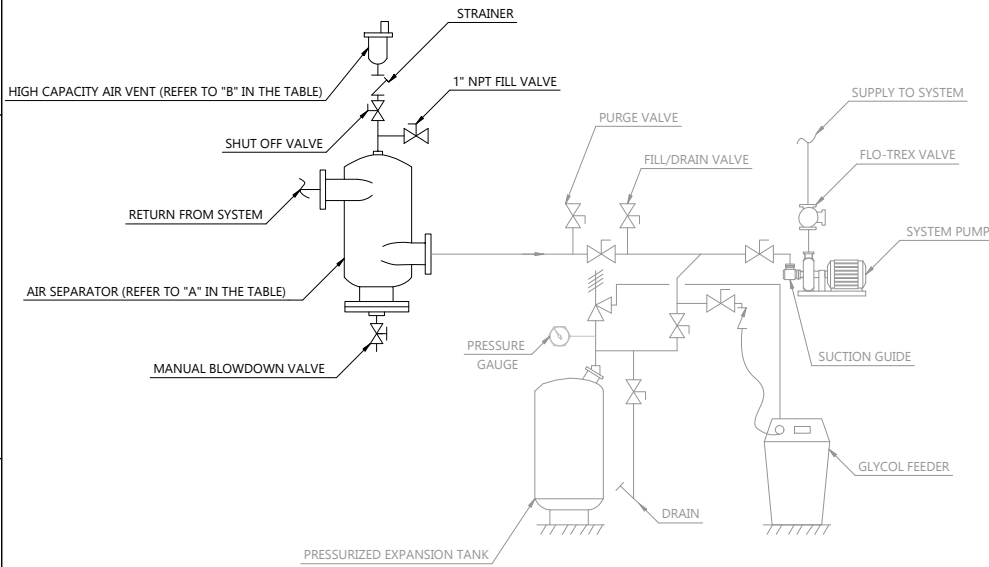

AIR SEPARATOR TYPICAL PIPING CONNECTIONS

AIR SEPARATOR AND AIR VENT SCHEDULE

DASH NUMBER (NON-INSULATED AIR SEPARATOR)	DASH NUMBER (1" INSULATED AIR SEPARATOR)	MANUFACTURER A	MODEL NUMBER A	MAX. FLOW RATE, USGPM FOR LINE VELOCITY, FT/S			MANUFACTURER B	MODEL NUMBER B
				4	6	8		
-01	-01/1	ARMSTRONG	VA-2 1/2	60	90	120	ARMSTRONG	AAE-750
-02	-02/1	ARMSTRONG	VA-4	160	240	320	ARMSTRONG	AAE-750
-03	-03/1	ARMSTRONG	VA-5	250	375	500	ARMSTRONG	AAE-750
-04	-04/1	ARMSTRONG	VA-6	360	540	720	ARMSTRONG	AAE-750
-05	-05/1	ARMSTRONG	VA-8	630	940	1250	ARMSTRONG	AAE-750
-06	-06/1	ARMSTRONG	VA-10	990	1500	1980	ARMSTRONG	AAE-750
-07	-07/1	ARMSTRONG	VA-12	1400	2100	2800	ARMSTRONG	AAE-750
-08	-08/1	ARMSTRONG	VA-14	1720	2580	3460	ARMSTRONG	AAE-750

MANUFACTURER NOTE:

- VISUALLY INSPECT THE AIR SEPARATOR FOR DAMAGE, WHICH MAY OCCUR DURING TRANSIT.
- A MANUAL DRAIN CAN BE ADDED TO HELP FACILITATE PURGING SEDIMENT FROM THE AIR SEPARATOR.
- AIR SEPARATORS SHOULD BE INSTALLED AT THE HIGHEST TEMPERATURE AND THE LOWEST PRESSURE POINTS IN THE SYSTEM. WHERE THIS IS NOT POSSIBLE, THE BEST LOCATION IS AT THE POINT OF HIGHEST TEMPERATURE. THE IDEAL LOCATION IN A HEATING SYSTEM FOR AN AIR SEPARATOR IS AT THE OUTLET OF THE HEAT SOURCE. FOR CHILLED WATER SYSTEMS, PLACE THE SEPARATOR IN THE RETURN TO THE CHILLER.

AIR SEPARATOR

SHUT-OFF VALVE
 MANUAL VALVE
 CHECK VALVE
 RELIEF VALVE
 AIR VENT
 MANUAL DRAIN

NEW EQUIPMENT

IBSDS M-805

COPYRIGHT AND DISCLAIMER
 THIS WORK IS THE SOLE PROPERTY OF I.B. STOREY INC AND IS INTENDED SOLELY FOR THE INFORMATION OF THE CLIENT. ALL RIGHTS RESERVED. THE WORK MAY NOT BE REPRODUCED OR DISTRIBUTED, WHOLE OR IN PART, WITHOUT THE PRIOR WRITTEN PERMISSION OF I.B. STOREY INC.
 THIS DOCUMENT MAY NOT BE USED FOR ANY OTHER PROJECTS OR WITHOUT INVOLVEMENT OF I.B. STOREY INC. ANY USE WHICH A THIRD PARTY MAKES OF THE WORK, OR ANY RELIANCE ON OR DECISIONS TO BE MADE BASED ON IT, ARE THE RESPONSIBILITY OF SUCH THIRD PARTIES.

FOR ILLUSTRATION ONLY

**- NOT FOR CONSTRUCTION -
 CONFIDENTIAL & PROPRIETARY**

12.0	30-AUG-24	H.A.
11.0	25-MAR-24	E.K.
10.0	04-OCT-23	H.D.
VER #	DATE	BY

I.B. STOREY
Rink Engineering Experts
 CHARLOTTETOWN PE
 VAUGHAN ON
 REDINGTON SHORES FL
 PLANO TX
 WWW.IBSTOREY.COM

STAMP

DRAWING NUMBER		IBSDS M-805	
DRAWING NAME		AIR SEPARATOR DESIGN STANDARD	
CLIENT		I.B. STOREY INC.	
PROJECT		IB STOREY DESIGN STANDARDS	
DRAWN BY	E.KADYROVA	CHECKED BY	J.RITCHIE
DATE	30-AUG-24	REVISION	12.0
SHEET SIZE	A	SHEET NO.	1 OF 1

A

B

C

D

E

NOTE:

- THIS STANDARD WAS ESTABLISHED TO PROVIDE ADDITIONAL INSIGHTS ON PIPING, CONNECTIONS, MODEL DESIGNATIONS, AND SIMILAR ASPECTS.
- REFER TO THE DASH NUMBER INDICATED ON THE P&ID FOR THE REQUISITE MODEL IDENTIFICATIONS OF THE FEEDER.
- ONLY EMPLOY THE MODEL ASSOCIATED WITH THE DASH NUMBER DELINEATED ON THE P&ID.

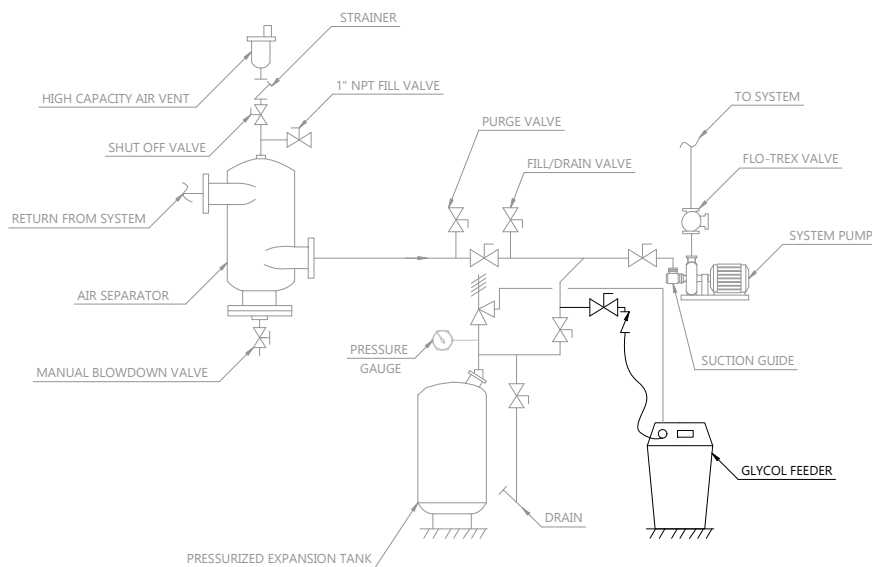
**GLYCOL FEEDER TYPICAL PIPING CONNECTIONS****GLYCOL FEEDER SCHEDULE**

DASH NUMBER	MANUFACTURER	MODEL NUMBER	VOLUME, USGAL	WEIGH WHEN FULL, LB	PUMP FLOWRATE, USGPM	POWER	V/H/PH
-0.1	AXIOM	DMF150	4.6	50	1.0	50 W	115/60/1
-0.2	AXIOM	DMF300	17	166	1.0	50 W	115/60/1
-0.3	AXIOM	MF200	6.6	60	0.7	50 W	115/60/1
-0.4	AXIOM	MF300	19	157	0.7	50 W	115/60/1
-0.5	AXIOM	SF100	55	525	1.4	0.7 A	115/60/1
-0.6	AXIOM	SF100L	100	940	1.7	0.7 A	115/60/1

DMF SERIES MANUFACTURER INSTALL NOTES

- SET SYSTEM FEEDER ON A SECURE AND LEVEL BASE OR ON THE PROVIDED WALL BRACKET.
- IF MOUNTING ON THE WALL, THE CARDBOARD CUT-OUT ON THE SIDE OF THE DMF BOX MAY BE USED TO LOCATE THE SCREW HOLES FOR THE WALL BRACKET.
- ENSURE THE WALL BRACKET IS LEVEL AND FASTENED SECURELY TO THE WALL.
- HANG AND FILL TANK PRIOR TO MAKING SYSTEM CONNECTION. THIS HELPS TO ENSURE THAT THE TANK IS SECURELY SEATED ON THE MOUNTING BRACKET

MF SERIES MANUFACTURER INSTALL NOTES:

- SET SYSTEM FEEDER ON A SECURE AND LEVEL BASE OR IN THE OPTIONAL TANK SHELF.
- CONNECT THE UNIT TO THE SYSTEM USING COPPER OR PLASTIC TUBING. ENSURE THAT THERE IS A SYSTEM ISOLATION VALVE INSTALLED TO ALLOW FOR ISOLATION OF THE UNIT. DO NOT INSTALL A CHECK VALVE OR PRESSURE REGULATOR BETWEEN SYSTEM FEEDER AND SYSTEM.
- MOUNT POWER SUPPLY AND SECURE WITH MOUNTING BRACKET. DO NOT POWER UP SYSTEM FEEDER UNTIL A SYSTEM CONNECTION IS MADE, ISOLATION VALVE IS CLOSED AND FEEDER VALVE IS SET TO MIX.
- TO CONNECT THE SYSTEM FEEDER TO THE RIA10-1-SAA ALARM PANEL REMOVE LOW LEVEL FLOAT SWITCH FROM CIRCUIT AND CONNECT TO AXIOM RIA10-1-SAA ALARM PANEL.
- INSTALL PROPER WATER/GLYCOL MIX IN THE TANK TO A LEVEL ABOVE MINIMUM LEVEL INDICATION ON TANK SCALE.
- CLOSE SYSTEM ISOLATION VALVE, TURN FEEDER VALVE TO VERTICAL POSITION (MIX POSITION).
- INSERT DC PLUG INTO THE SYSTEM FEEDER FIRST, AND THEN PLUG POWER SUPPLY INTO 120V OUTLET. THE RED LED IN THE POWER SUPPLY CORD SHOULD LIGHT UP. IF IT DOES NOT, CHECK THE FUSE AND POWER RECEPTACLE.
- ONCE THE PUMP IS PRIMED, TURN THE FEEDER VALVE HANDLE TO HORIZONTAL POSITION (RUN POSITION), OPEN SYSTEM ISOLATION VALVE AND ALLOW PUMP TO PRESSURIZE SYSTEM. IF SYSTEM PRESSURE IS BELOW PRESSURE SWITCH SETTING (18 PSI), THE PUMP WILL START. THE SYSTEM FEEDER WILL RUN UNTIL SYSTEM IS PRESSURIZED TO APPROXIMATELY 18 PSI AND SHUT-OFF. IT MAY CYCLE RAPIDLY A NUMBER OF TIMES WHILE SYSTEM PRESSURE STABILIZES AND WHILE AIR IS REMOVED FROM THE SYSTEM. THE CYCLING WILL STOP ONCE SYSTEM PRESSURE RISES ABOVE 18 PSI DUE TO THERMAL EXPANSION.
- IF A HIGHER FILL PRESSURE IS REQUIRED (UP TO 25 PSI) THE INTERNAL PRESSURE SWITCH MAY BE ADJUSTED BY TURNING THE CENTER ADJUSTING SCREW COUNTER CLOCKWISE TO INCREASE PRESSURE. ACCESS TO THE PRESSURE SWITCH CAN BE GAINED BY LIFTING THE LEFT SIDE OF THE TOP COVER.

SF100, SF100-L SERIES MANUFACTURER INSTALL NOTES:

- SET THE SOLUTION FEEDER ON A SECURE AND LEVEL BASE.
- CONNECT THE FLEXIBLE HOSE SUPPLIED WITH THE UNIT TO YOUR SYSTEM CONNECTION POINT - USE A UNION AND ISOLATION VALVE TO ALLOW FOR FUTURE SERVICE.
- THE CHECK VALVE SUPPLIED WITH THE UNIT MUST BE ON THE SYSTEM END OF THE FLEXIBLE HOSE.
- RELIEF AND DRAIN VALVES MAY BE PIPED TO THE SF100 TANK, BUT ANY HOLES FOR ENTRY OF THESE PIPES SHOULD BE CUT INTO THE SIDE OF THE TANK NEAR THE TOP RATHER THAN THROUGH THE COVER. THIS WILL ALLOW THE COVER AND TOP TO BE EASILY REMOVED IF NECESSARY.
- FILL THE SF100 TANK WITH FLUID.
- THE UNIT IS SUITABLE FOR WATER OR GLYCOL/WATER SOLUTIONS OF UP TO 50% GLYCOL CONCENTRATION.

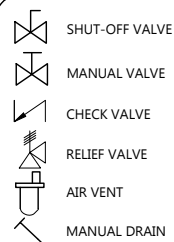
GLYCOL FEEDER

NEW EQUIPMENT

COPYRIGHT AND DISCLAIMER

THIS WORK IS THE SOLE PROPERTY OF I.B. STOREY INC AND IS INTENDED SOLELY FOR THE INFORMATION OF THE CLIENT. ALL RIGHTS RESERVED. THE WORK MAY NOT BE REPRODUCED OR DISTRIBUTED, WHOLE OR IN PART, WITHOUT THE PRIOR WRITTEN PERMISSION OF I.B. STOREY INC. THIS DOCUMENT MAY NOT BE USED FOR ANY OTHER PROJECTS OR WITHOUT INVOLVEMENT OF I.B. STOREY INC. ANY USE WHICH A THIRD PARTY MAKES OF THE WORK, OR ANY RELIANCE ON OR DECISIONS TO BE MADE BASED ON IT, ARE THE RESPONSIBILITY OF SUCH THIRD PARTIES.

FOR ILLUSTRATION ONLY

**- NOT FOR CONSTRUCTION -
CONFIDENTIAL & PROPRIETARY**

10.0	30-AUG-24	H.A.
9.0	25-MAR-24	E.K.
8.0	15-JUN-23	T.V.V.
VER #	DATE	BY



STAMP

DRAWING NUMBER

IBSDS M-809

DRAWING NAME

GLYCOL FEEDER DESIGN STANDARDS

CLIENT

I.B. STOREY INC.

PROJECT

IB STOREY DESIGN STANDARDS

DRAWN BY

E.KADYROVA

CHECKED BY

J.RITCHIE

DATE

30-AUG-24

REVISION

10.0

SHEET SIZE

A

SHEET NO.

1 OF 1

A

B

C

D

E

IBSDS M-809

NOTE:
 - THIS STANDARD WAS ESTABLISHED TO PROVIDE ADDITIONAL INSIGHTS ON PIPING, CONNECTIONS, MODEL DESIGNATIONS, AND SIMILAR ASPECTS.
 - REFER TO THE DASH NUMBER INDICATED ON THE P&ID FOR THE REQUISITE MODEL IDENTIFICATIONS OF THE EXPANSION TANK.
 - ONLY EMPLOY THE MODEL ASSOCIATED WITH THE DASH NUMBER DELINEATED ON THE P&ID.

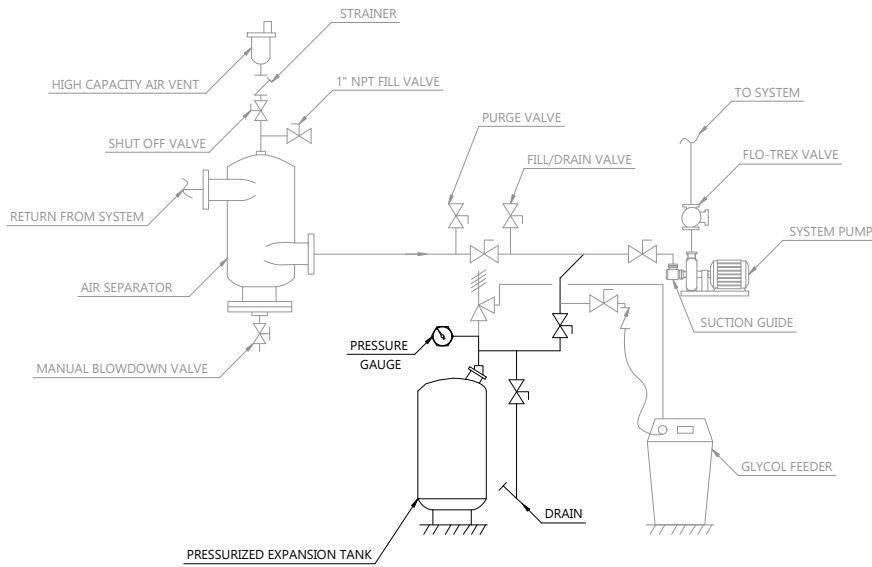

EXPANSION TANK TYPICAL PIPING CONNECTIONS

EXPANSION TANK SCHEDULE					
DASH NUMBER	TANK VOLUME, GAL	ACCEPTANCE VOLUME, GAL	MANUFACTURER	MODEL NUMBERS	QTY.
-01	8	6.3	ARMSTRONG	AX-15	1
-02	11	8.8	ARMSTRONG	AX-20	1
-03	25	20.2	ARMSTRONG	AX-40	1
-04	35	28	ARMSTRONG	AX-60	1
-05	45	36	ARMSTRONG	AX-80	1
-06	60	48.5	ARMSTRONG	AX-100	1
-07	70	56.5	ARMSTRONG	AX-120	1
-08	80	65	ARMSTRONG	AX-144	1
-09	90	73	ARMSTRONG	AX-180	1
-10	115	93	ARMSTRONG	AX-200	1
-11	140	113.5	ARMSTRONG	AX-240	1
-12	158	128	ARMSTRONG	AX-260	1
-13	211	171	ARMSTRONG	AX-280	1
-14	53	53	ARMSTRONG	A200-L	1
-15	80	80	ARMSTRONG	A300-L	1
-16	106	106	ARMSTRONG	A400-L	1
-17	132	132	ARMSTRONG	A500-L	1
-18	158	158	ARMSTRONG	A600-L	1
-19	211	211	ARMSTRONG	A800-L	1
-20	264	264	ARMSTRONG	A1000-L	1
-21	317	317	ARMSTRONG	A1200-L	1
-22	370	370	ARMSTRONG	A1400-L	1
-23	422	422	ARMSTRONG	1600-L	1
-24	528	528	ARMSTRONG	2000-L	1
-25	660	660	ARMSTRONG	2500-L	1
-26	792	792	ARMSTRONG	3000-L	1
-27	1056	1056	ARMSTRONG	4000-L	1
-28	1320	1320	ARMSTRONG	5000-L	1

MANUFACTURER NOTES:

- VISUALLY INSPECT TANK FOR DAMAGE, WHICH MAY OCCUR DURING TRANSIT.
- FACTORY PRE-CHARGE PRESSURE MAY NOT BE CORRECT FOR THE INSTALLATION. TANK MUST BE PRE-CHARGED TO SYSTEM DESIGN FILL PRESSURE BEFORE PLACING INTO OPERATION. REMOVE PIPE PLUG COVERING THE VALVE ENCLOSURE. CHECK AND ADJUST THE CHARGE PRESSURE BY ADDING OR RELEASING AIR FOR EACH APPLICATION.
- IF THE SYSTEM HAS BEEN FILLED, THE TANK MUST BE ISOLATED FROM THE SYSTEM AND THE TANK EMPTIED BEFORE CHARGING. THIS ENSURES ALL FLUID HAS EXITED THE DIAPHRAGM AREA AND PROPER CHARGING WILL OCCUR.
- IF THE PRE-CHARGE ADJUSTMENT IS NECESSARY, OIL AND WATER FREE COMPRESSED AIR OR NITROGEN GAS MAY BE USED. CHECK THE PRE-CHARGE USING AN ACCURATE PRESSURE GAUGE AT THE CHARGING VALVE AND ADJUST AS REQUIRED. CHECK AIR VALVE FOR LEAKAGE. IF EVIDENT, REPLACE THE SCHRADER-TYPE TIRE VALVE CORE. DO NOT DEPEND ON THE VALVE CAP TO SEAL THE LEAK. AFTER MAKING SURE AIR CHARGE IS CORRECT, REPLACE PIPE PLUG OVER THE CHARGING VALVE FOR PROTECTION.
- SET TANK IN PLACE AND PIPE SYSTEM CONNECTION TO SYSTEM. BE SURE TO INCLUDE ISOLATION VALVE(S) AND DRAIN.
- PURGE AIR FROM SYSTEM BEFORE PLACING TANK INTO OPERATION. ALL MODELS HAVE SYSTEM WATER CONTAINED BEHIND DIAPHRAGM.
- WHEN FILLING THE SYSTEM WITH GLYCOL, OPEN VALVES TO TANK TO ENSURE THAT ANY RESIDUAL AIR IN THE TANK IS DISPLACED BY GLYCOL.
- IT IS RECOMMENDED THAT THE PRE-CHARGE BE CHECKED ANNUALLY TO ENSURE PROPER SYSTEM PROTECTION AND LONG LIFE FOR THE VESSEL.

GLYCOL SYSTEM EXPANSION TANK

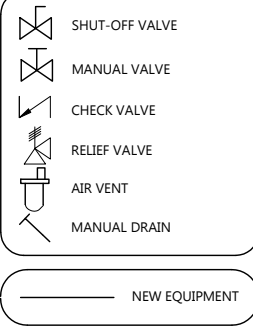

COPYRIGHT AND DISCLAIMER
 THIS WORK IS THE SOLE PROPERTY OF I.B. STOREY INC AND IS INTENDED SOLELY FOR THE INFORMATION OF THE CLIENT. ALL RIGHTS RESERVED. THE WORK MAY NOT BE REPRODUCED OR DISTRIBUTED, WHOLE OR IN PART, WITHOUT THE PRIOR WRITTEN PERMISSION OF I.B. STOREY INC.
 THIS DOCUMENT MAY NOT BE USED FOR ANY OTHER PROJECTS OR WITHOUT INVOLVEMENT OF I.B. STOREY INC. ANY USE WHICH A THIRD PARTY MAKES OF THE WORK, OR ANY RELIANCE ON OR DECISIONS TO BE MADE BASED ON IT, ARE THE RESPONSIBILITY OF SUCH THIRD PARTIES.
 FOR ILLUSTRATION ONLY
- NOT FOR CONSTRUCTION - CONFIDENTIAL & PROPRIETARY

11.0	30-AUG-24	H.A.
10.0	25-MAR-24	E.K.
9.0	15-JUN-23	T.V.V.
VER #	DATE	BY

I.B. STOREY
Rink Engineering Experts
 CHARLOTTETOWN PE
 VAUGHAN ON
 REDINGTON SHORES FL
 PLANO TX
 WWW.IBSTOREY.COM

STAMP

DRAWING NUMBER		IBSDS M-811	
DRAWING NAME		EXPANSION TANK DESIGN STANDARDS	
CLIENT		I.B. STOREY INC.	
PROJECT		IB STOREY DESIGN STANDARDS	
DRAWN BY	E.KADYROVA	CHECKED BY	J.RITCHIE
DATE	30-AUG-24	REVISION	11.0
SHEET SIZE	A	SHEET NO.	1 OF 1

RENTAL CHILLER CONNECTIONS DETAIL

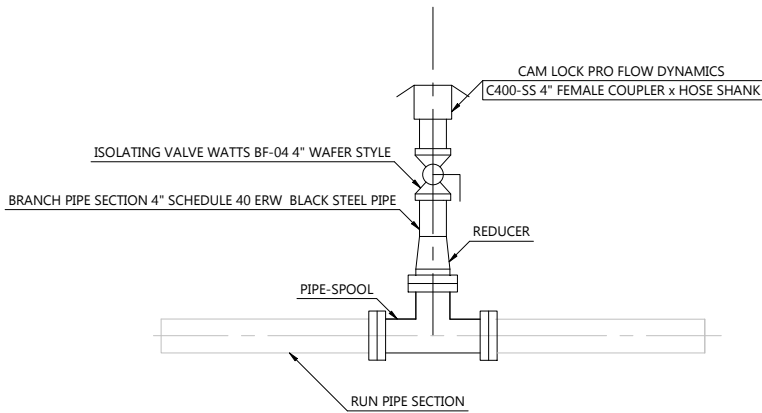

COPYRIGHT AND DISCLAIMER
 THIS WORK IS THE SOLE PROPERTY OF I.B. STOREY INC AND IS INTENDED SOLELY FOR THE INFORMATION OF THE CLIENT. ALL RIGHTS RESERVED. THE WORK MAY NOT BE REPRODUCED OR DISTRIBUTED, WHOLE OR IN PART, WITHOUT THE PRIOR WRITTEN PERMISSION OF I.B. STOREY INC.
 THIS DOCUMENT MAY NOT BE USED FOR ANY OTHER PROJECTS OR WITHOUT INVOLVEMENT OF I.B. STOREY INC. ANY USE WHICH A THIRD PARTY MAKES OF THE WORK, OR ANY RELIANCE ON OR DECISIONS TO BE MADE BASED ON IT, ARE THE RESPONSIBILITY OF SUCH THIRD PARTIES.

FOR ILLUSTRATION ONLY

**- NOT FOR CONSTRUCTION -
 CONFIDENTIAL & PROPRIETARY**

4.0	27-MAR-24	E.K.
3.0	21-APR-23	E.K.
2.0	08-FEB-21	E.K.
VER #	DATE	BY

RENTAL CHILLER CONNECTIONS SCHEDULE

DASH NUMBER	PIPE SPOOL	QTY.	REDUCER	QTY.	CAM LOCK	ISOLATING VALVE	BRANCH PIPE SECTION
-01	6" FLANGES	1	6" x 4"	1	PRO FLOW DYNAMICS, C400-SS, 4" FEMALE COUPLER x HOSE SHANK	WATTS, BF-04, 4" WAFER STYLE	4" SCHEDULE 40 ERW BLACK STEEL PIPE
-02	8" FLANGES	1	8" x 4"	1	PRO FLOW DYNAMICS, C400-SS, 4" FEMALE COUPLER x HOSE SHANK	WATTS, BF-04, 4" WAFER STYLE	4" SCHEDULE 40 ERW BLACK STEEL PIPE
-03	10" FLANGES	1	10" x 4"	1	PRO FLOW DYNAMICS, C400-SS, 4" FEMALE COUPLER x HOSE SHANK	WATTS, BF-04, 4" WAFER STYLE	4" SCHEDULE 40 ERW BLACK STEEL PIPE
-04	12" FLANGES	1	12" x 6"	1	PRO FLOW DYNAMICS, C600-SS, 6" FEMALE COUPLER x HOSE SHANK	WATTS, BF-06, 6" WAFER STYLE	6" SCHEDULE 40 ERW BLACK STEEL PIPE

NOTE:
 - TO ENSURE UNINTERRUPTED OPERATION DURING EQUIPMENT FAILURE OR REPLACEMENT, A RENTAL CHILLER IS REQUIRED.
 - ENSURE THAT THE PUMP BYPASS VALVE, AS INDICATED ON THE P&ID AS MANUALLY NORMALLY CLOSED, IS OPEN DURING RENTAL CHILLER OPERATION.



CHARLOTTETOWN PE
 VAUGHAN ON
 REDINGTON SHORES FL
 PLANO TX

WWW.IBSTOREY.COM

STAMP

DRAWING NUMBER		IBSDS M-815
DRAWING NAME		RENTAL CHILLER DESIGN STANDARDS
CLIENT		I.B. STOREY INC.
PROJECT		IB STOREY DESIGN STANDARDS
DRAWN BY	CHECKED BY	
E.KADYROVA	J.RITCHIE	
DATE	REVISION	
27-MAR-24	4.0	
SHEET SIZE	SHEET NO.	
A	1 OF 1	

Appendix C

Project Schedules

ID	TP	Task Name	Start	Finish	Duration	2025											
						Jan	Feb	Mar	Apr	May	Jun	Jul	Aug	Sep	Oct	Nov	Dec
1		Step 5: Construct	1/1/2025	9/24/2025	38w 1d	[Blue bar spanning from Jan to Aug]											
2	2	Connect Rinks #1 and #2 to New Plant	9/5/2025	9/5/2025	1d	[Vertical bar in Sep]											
3	2	Install New Refrigeration Plant Piping	7/22/2025	8/18/2025	4w	[Blue bar in Jul]											

Schedule As Tendered



Appendix D

Bidder Evaluation Criteria

Table 1: Evaluation Matrix

DESCRIPTION OF FACTOR	WEIGHT	TOTAL WEIGHT FOR SECTION
A. Understanding of Scope of Work		
COMPLIANCE WITH TENDER: A brief description of the company. Include a history of the company size, location, and areas of professional expertise. Specification of recommended installation, with detail that meets or exceeds the specifications outlined in the scope of work.	20	/30
DEMONSTRATED PERFORMANCE OF PROPOSED EQUIPMENT/SYSTEM: Proponents must stipulate that installation will occur as necessary to fulfill applicable codes and standards as they apply to refrigeration and mechanical systems.	10	
B. Proponents' Capability and Experience		
DESCRIPTION OF KEY PERSONNEL AND THEIR INVOLVEMENT WITH THE PROJECT: A list of the key personnel who would be involved including any sub-consultants or sub-contractors.	10	/35
DEMONSTRATED TECHNICAL ABILITY (PREVIOUS EXPERIENCE PROVIDING SIMILAR SERVICES): Clearly outline demonstrated experience and understanding of the scope of work	10	
PERFORMANCE BASED CONSTRUCTION EXPERIENCE IN SIMILAR APPLICATIONS: Only companies having successfully completed a minimum of 5 related projects.	10	
PROPOSED CONSTRUCTION SCHEDULE: Provide a proposed construction schedule for the installation of the scope of work	5	
C. Cost of Service		
COST OF SERVICE: Proponent shall provide the total cost of the project. The proposed cost is to be turnkey. Taxes are to be added as a separate item.	35	/35
Subtotal		/100

MEMORANDUM

TO: ALL BIDDERS **COMPANY:** N/A
FROM: I.B. STOREY INC.
SUBJECT: 24-009 SPRINGFIELD PLANT REPLACEMENT – TP-2 ADDENDUM #1
DATE: 11-DEC-24

The following Addendum is being provided for *24-009 SPD TP-2 Project Manual v1.0, Appendix A: Contract Specifications, TP 2 – Piping Connections & Insulation:*

Part 2 - Details:

Was: GF-1 & GF-2 selected as per 24009 TP2 PKG02 Appendix B: 24009 M-605 (3, B1)

2.1.11. [Not included]

2.1.12. [Not included]

Is Now: Added for clarity to tender specifications

2.1.11. Supply and install one (1) Automatic Cold Loop Feeder (GF-1)

- .1 Size: 100 Gallons
- .2 Tank Material: Plastic
- .3 Include pump with automatic pressure controls
- .4 Must include a diverting valve.
- .5 Must include a fluid level switch to automatically shut the pump off at a low tank level.
- .6 Standard of Acceptance: Axiom SF-100L, or approved equivalent.

2.1.12. Supply and install one (1) Automatic Warm Loop Feeder (GF-2)

- .7 Size: 100 Gallons
- .8 Tank Material: Plastic
- .9 Include pump with automatic pressure controls
- .10 Must include a diverting valve.
- .11 Must include a fluid level switch to automatically shut the pump off at a low tank level.
- .12 Standard of Acceptance: Axiom SF-100L, or approved equivalent.



Part 6 – Water Piping

Was:

- 3.8.8. Pipe hangers must include rubber lining on the inside of the clamp to prevent pipe wear, unless the pipe is insulated.

Is Now:

- 3.8.8. Pipe hangers must include rubber lining on the inside of the clamp to prevent pipe wear, unless the pipe is insulated.
- .1 Piping to be supported from existing structure. Contractor is responsible for verifying that the existing room structure is adequate to support the pipes.

The following Addendum is being provided for *24-009 SPD TP-2 Project Manual v1.0, Appendix B: Contract Drawing Package, 24-009 PKG02 – TP2 Piping Connections & Insulation Drawings v1.0*

Was:

- 24009 PGK02 TP2 Piping Connections & Insulation v1.0
- 24009 MP413 Plant Room Cooling Piping Large-Scale View v1.0
- 24009 MP415 Plant Room Warm Piping Large-Scale View v1.0
- 24009 MP911 Cooling Piping Isometric View v1.0
- 24009 MP913 Heating Piping Isometric View v1.0

Is Now:

- 24009 PGK02 TP2 Piping Connections & Insulation v2.0
- 24009 MP413 Plant Room Cooling Piping Large-Scale View v2.0
- 24009 MP415 Plant Room Warm Piping Large-Scale View v2.0
- 24009 MP911 Cooling Piping Isometric View v2.0
- 24009 MP913 Heating Piping Isometric View v2.0

Replace drawings for 24-009 PKG02 - TP2 Piping Connections & Insulation Drawings v1.0 with v2.0 drawings attached with TP-2 Addendum #1.

I.B. STOREY

Rink Engineering Experts

WWW.IBSTOREY.COM

IBS DRAWING SHEET DEFINITION

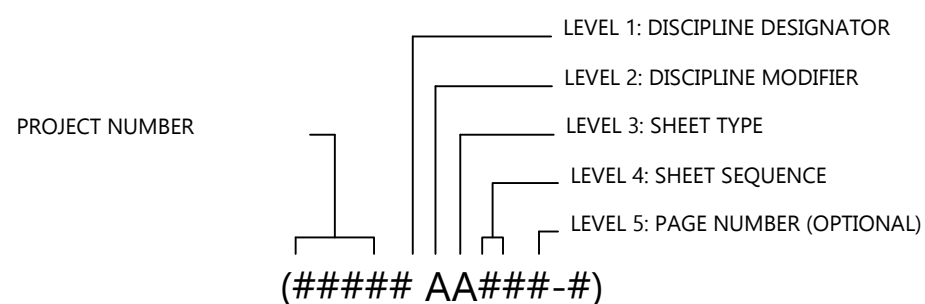

LEVEL 1 DISCIPLINE DESIGNATOR		LEVEL 2 DISCIPLINE MODIFIER		LEVEL 3 SHEET TYPE		LEVEL 4 SHEET SEQUENCE	
A	ARCHITECTURAL	-	MODIFIER NOT USED	0	GENERAL	01-99	SEQUENTIAL VALUE
B	GEOTECHNICAL	M	B BOARDS & GLASS	1	PLANS	ODD	DISTINCT DRAWINGS
C	CIVIL		D DEMOLITION	2	ELEVATIONS	EVEN	MIRROR DRAWINGS
D	PROCESS		H HVAC	3	SECTIONS		
E	ELECTRICAL		I INSTRUMENTATION	4	LARGE-SCALE VIEWS		
F	FIRE PROTECTION		P PIPING	5	DETAILS		
H	HAZARDOUS MATERIALS		R RINK FLOOR	6	SCHEDULES & DIAGRAMS		
I	INTERIORS			7	COORDINATION		
L	LANDSCAPE			8	DESIGN STANDARD		
M	MECHANICAL			9	3D REPRESENTATIONS		
O	OPERATIONS						
P	PLUMBING						
Q	EQUIPMENT						
R	RESOURCE						
S	STRUCTURAL						
T	TELECOMMUNICATIONS						
V	SURVEY/MAPPING						
W	DISTRIBUTED ENERGY						
X	OTHER DISCIPLINES						
Z	CONTRACTOR/SHOP DRAWINGS						

REVISION LOG				
DRAWING #	DRAWING NAME	VER:	ISSUED FOR:	DATE
24009 M-605	PIPING SCHEMATICS	VER: 1.0	ISSUED FOR TENDER	21-NOV-24
24009 MP413	PLANT ROOM COOLING PIPING LARGE-SCALE VIEW	VER: 2.0	TP2 ADDENDUM #1	11-DEC-24
24009 MP415	PLANT ROOM WARM PIPING LARGE-SCALE VIEW	VER: 1.0	TP2 ADDENDUM #1	11-DEC-24
24009 MP417	PLANT ROOM RELIEF PIPING LARGE-SCALE VIEW	VER: 1.0	ISSUED FOR TENDER	21-NOV-24
24009 MP419	PLANT ROOM WATER PIPING LARGE-SCALE VIEW	VER: 1.0	ISSUED FOR TENDER	21-NOV-24
24009 MP421	SNOW MELT PIT PIPING LARGE-SCALE VIEW	VER: 1.0	ISSUED FOR TENDER	21-NOV-24
24009 MP423	PLANT ROOM MISC. EQUIPMENT LARGE-SCALE VIEWS	VER: 1.0	ISSUED FOR TENDER	21-NOV-24
24009 MP911	COOLING PIPING ISOMETRIC VIEW	VER: 2.0	TP2 ADDENDUM #1	11-DEC-24
24009 MP913	HEATING PIPING ISOMETRIC VIEW	VER: 2.0	TP2 ADDENDUM #1	11-DEC-24
24009 MP915	RELIEF PIPING ISOMETRIC VIEW	VER: 1.0	ISSUED FOR TENDER	21-NOV-24
24009 MP917	WATER PIPING ISOMETRIC VIEW	VER: 1.0	ISSUED FOR TENDER	21-NOV-24
IBSDS M801	GLYCOL RELIEF VALVES STANDARD	VER: 10.0	ISSUED FOR TENDER	30-AUG-24
IBSDS M805	AIR SEPARATOR STANDARD	VER: 12.0	ISSUED FOR TENDER	30-AUG-24
IBSDS M809	GLYCOL FEEDER STANDARD	VER: 10.0	ISSUED FOR TENDER	30-AUG-24
IBSDS M811	EXPANSION TANK STANDARD	VER: 11.0	ISSUED FOR TENDER	30-AUG-24
IBSDS M815	RENTAL CHILLER STANDARD	VER: 4.0	ISSUED FOR TENDER	27-MAR-24

PLEASE REMOVE THE FOLLOWING DRAWINGS:

- 24009 PKG02 - TP2 PIPING CONNECTIONS & INSULATION v1.0
- 24009 MP413 - PLANT ROOM COOLING PIPING LARGE-SCALE VIEW v1.0
- 24009 MP415 - PLANT ROOM WARM PIPING LARGE-SCALE VIEW v1.0
- 24009 MP911 - COOLING PIPING ISOMETRIC VIEW v1.0
- 24009 MP913 - HEATING PIPING ISOMETRIC VIEW v1.0

PLEASE REPLACE THE REMOVED DRAWINGS WITH THE FOLLOWING DRAWINGS:

- 24009 PKG02 - TP2 PIPING CONNECTIONS & INSULATION v2.0
- 24009 MP413 - PLANT ROOM COOLING PIPING LARGE-SCALE VIEW v2.0
- 24009 MP415 - PLANT ROOM WARM PIPING LARGE-SCALE VIEW v2.0
- 24009 MP911 - COOLING PIPING ISOMETRIC VIEW v2.0
- 24009 MP913 - HEATING PIPING ISOMETRIC VIEW v2.0

REVISION LOG

NOTES

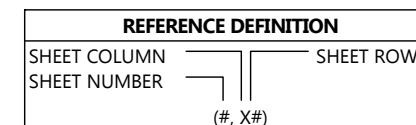

COPYRIGHT AND DISCLAIMER

THIS WORK IS THE SOLE PROPERTY OF I.B. STOREY INC AND IS INTENDED SOLELY FOR THE INFORMATION OF THE CLIENT. ALL RIGHTS RESERVED. THE WORK MAY NOT BE REPRODUCED OR DISTRIBUTED, WHOLE OR IN PART, WITHOUT THE PRIOR WRITTEN PERMISSION OF I.B. STOREY INC. THIS DOCUMENT MAY NOT BE USED FOR ANY OTHER PROJECTS OR WITHOUT INVOLVEMENT OF I.B. STOREY INC. ANY USE WHICH A THIRD PARTY MAKES OF THE WORK, OR ANY RELIANCE ON OR DECISIONS TO BE MADE BASED ON IT, ARE THE RESPONSIBILITY OF SUCH THIRD PARTIES.

- NOT FOR CONSTRUCTION -
CONFIDENTIAL & PROPRIETARY

VER #	REVISIONS	DATE	BY
2.0	TP2 ADDENDUM #1	11-DEC-24	H.A.
1.0	ISSUED FOR TENDER	21-NOV-24	H.A.



CHARLOTTETOWN PE
VAUGHAN ON
REDINGTON SHORES FL
PLANO TX

WWW.IBSTOREY.COM

STAMP	
DRAWING NUMBER	24009 PKG02
DRAWING NAME	TP2 PIPING CONNECTIONS & INSULATION
CLIENT	SPRINGFIELD PARK DISTRICT
PROJECT	SPRINGFIELD - PLANT REPLACEMENT
DRAWN BY	H.AKAR
CHECKED BY	J.RITCHIE
DATE	11-DEC-24
REVISION	2.0
SHEET SIZE	C
SHEET NO.	1 OF 1

24009 PKG02

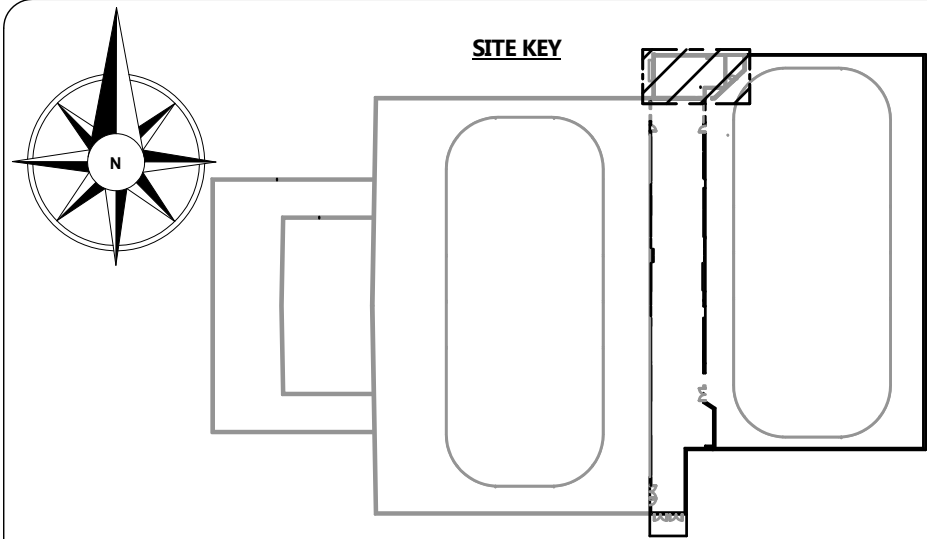

GLYCOL FILLING/TESTING:

- SUPPLY AND INSTALL A NEW CHARGE OF GLYCOL FOR ALL PLANT ROOM EQUIPMENT
- CONTRACTOR TO CARRY ALL PROCUREMENT, TRANSPORTATION, TESTING, AND LABOR REQUIRED TO PROVIDE THE GLYCOL CHARGE
- FLUID: 40% ETHYLENE GLYCOL, INCLUDING ALL REQUIRED ADDITIVES AND INHIBITORS
- AFTER CHARGING OF THE SYSTEM, THE CONTRACTOR IS REQUIRED TO ADJUST THE CONCENTRATION TO THE DESIRED AMOUNT
- TESTING MUST BE COMPLETED DEMONSTRATING THAT THE REQUIRED CONCENTRATION HAS BEEN ACHIEVED. PROVIDE ALL TESTING REPORTS TO THE CONSULTANT
- STANDARD OF ACCEPTANCE: DOW CHEMICAL'S AMBITROL FL40, OR EQUIVALENT

AUTOMATION VALVES:

- INSTALLED BY CONTRACTOR OF THE SCOPE AND SUPPLY BY OTHERS

NOTES

REFERENCE DEFINITION	
SHEET COLUMN	SHEET ROW
SHEET NUMBER	(#, X#)

COPYRIGHT AND DISCLAIMER
 THIS WORK IS THE SOLE PROPERTY OF I.B. STOREY INC AND IS INTENDED SOLELY FOR THE INFORMATION OF THE CLIENT. ALL RIGHTS RESERVED. THE WORK MAY NOT BE REPRODUCED OR DISTRIBUTED, WHOLE OR IN PART, WITHOUT THE PRIOR WRITTEN PERMISSION OF I.B. STOREY INC.
 THIS DOCUMENT MAY NOT BE USED FOR ANY OTHER PROJECTS OR WITHOUT INVOLVEMENT OF I.B. STOREY INC. ANY USE WHICH A THIRD PARTY MAKES OF THE WORK, OR ANY RELIANCE ON OR DECISIONS TO BE MADE BASED ON IT, ARE THE RESPONSIBILITY OF SUCH THIRD PARTIES.

- NOT FOR CONSTRUCTION -
 CONFIDENTIAL & PROPRIETARY

VER #	REVISIONS	DATE	BY
2.0	TP2 ADDENDUM #1	11-DEC-24	H.D.
1.0	ISSUED FOR TENDER	21-NOV-24	H.D.



CHARLOTTETOWN PE
 VAUGHAN ON
 REDINGTON SHORES FL
 PLANO, TX

WWW.IBSTOREY.COM

DRAWING NUMBER	
24009 MP413	
DRAWING NAME	
PLANT ROOM COOLING PIPING LARGE-SCALE VIEW	
CLIENT	
SPRINGFIELD PARK DISTRICT	
PROJECT	
SPRINGFIELD-PLANT REPLACEMENT	
DRAWN BY	CHECKED BY
H.DHAMELIYA	J.RITCHIE
DATE	REVISION
11-DEC-24	2.0
SHEET SIZE	SHEET NO.
C	1 OF 2

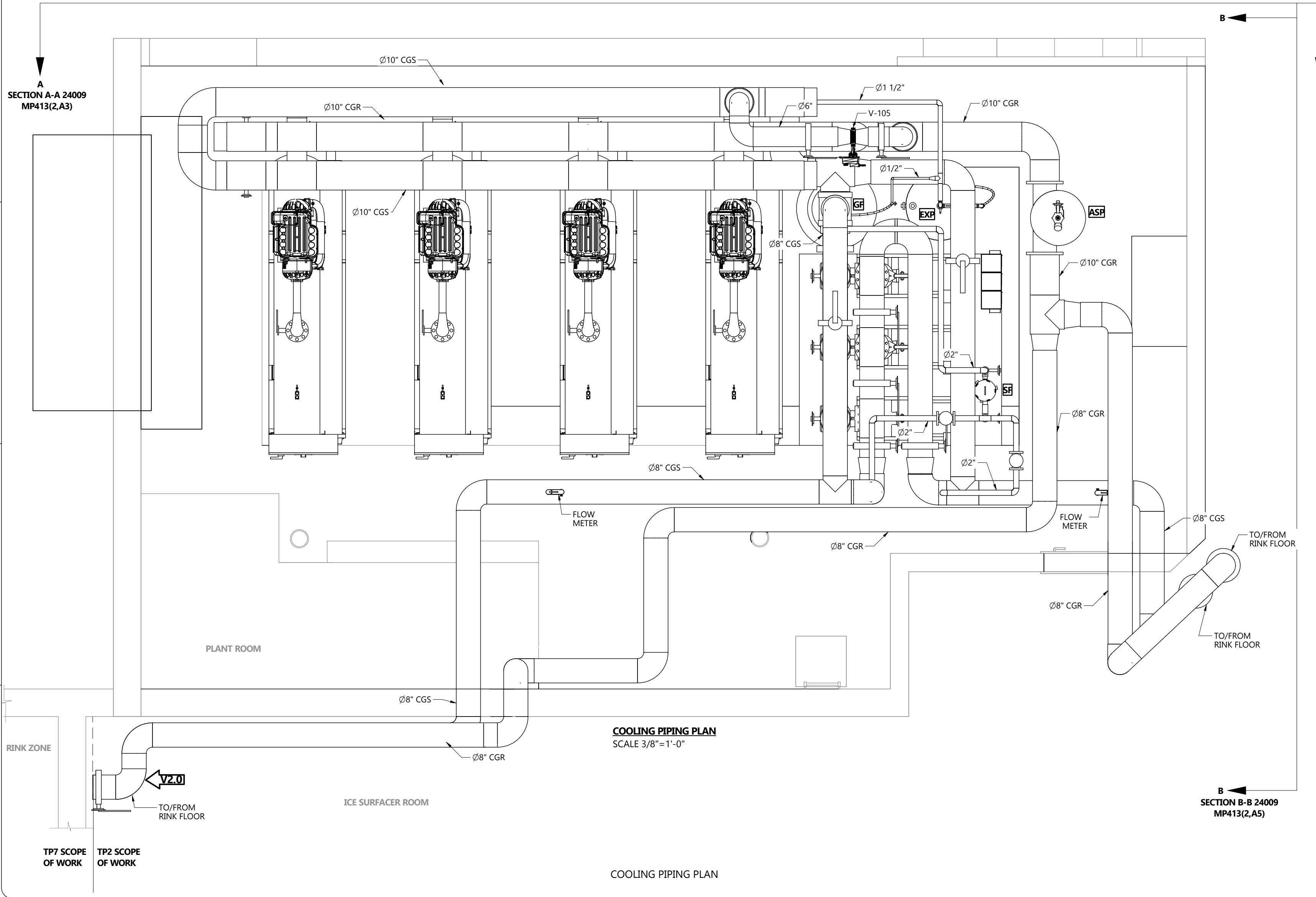

COOLING PIPING PLAN
 SCALE 3/8" = 1'-0"

COOLING PIPING PLAN

SECTION A-A 24009
 MP413(2,A3)

SECTION B-B 24009
 MP413(2,A5)

TP7 SCOPE
 OF WORK

TP2 SCOPE
 OF WORK

24009 MP413

1

2

3

4

5

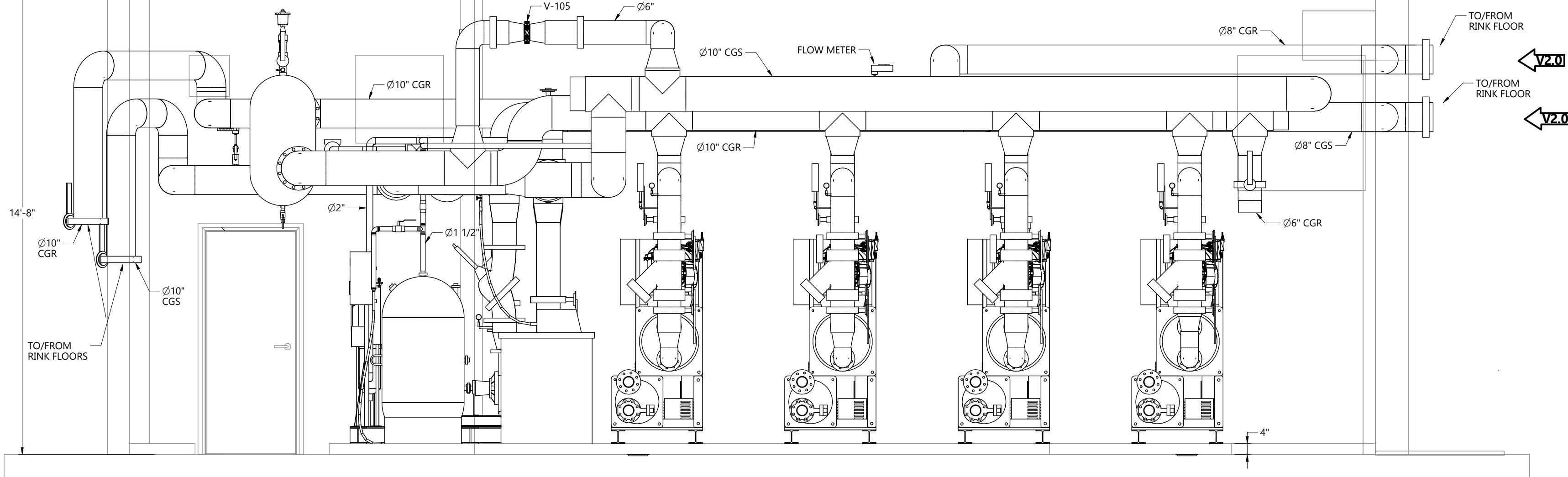

SECTION VIEW A-A 180° (24009 MP413.1.A2)
SCALE 3/8" = 1'-0"

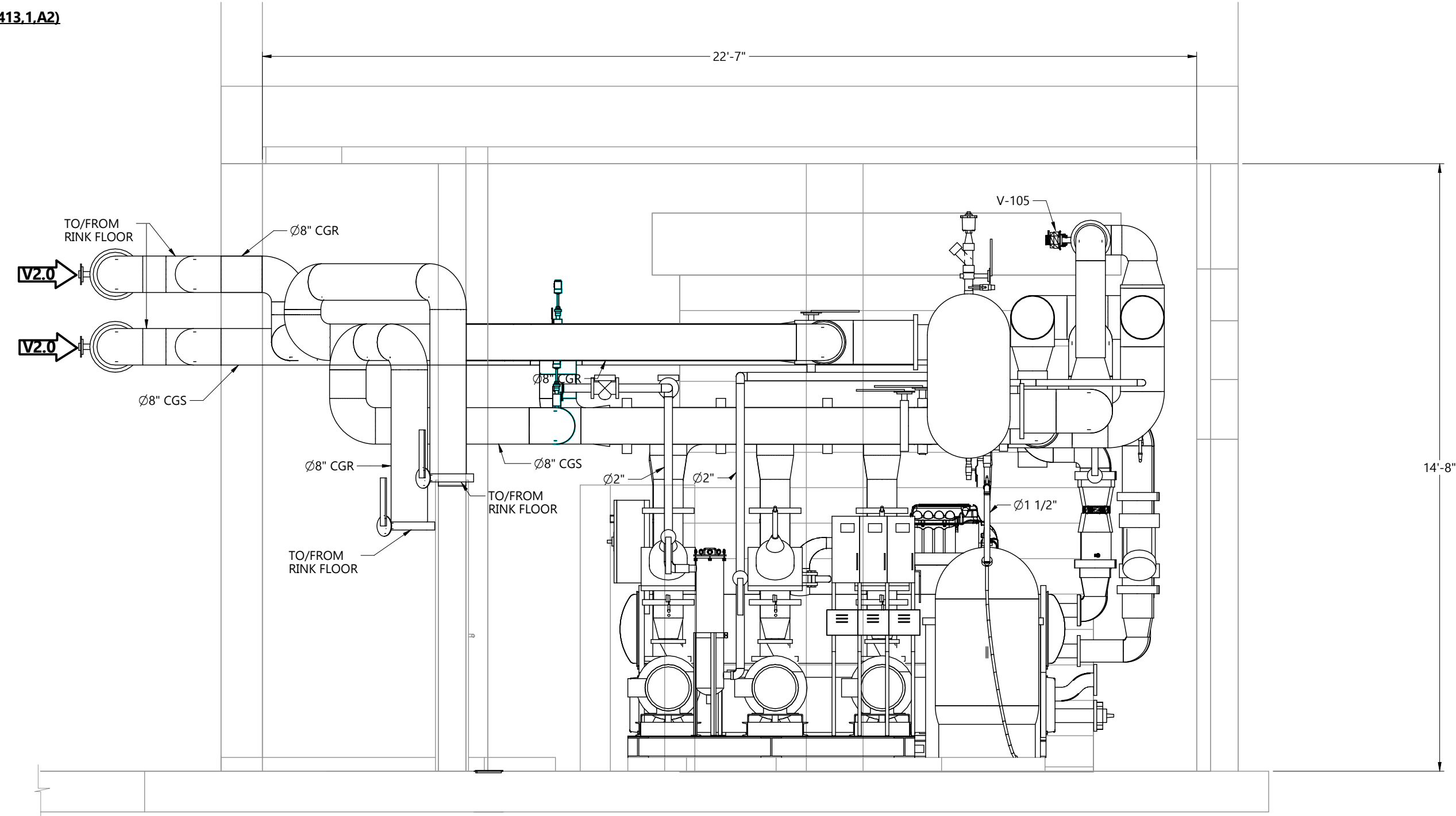

SECTION VIEW B-B 90° (24009 MP413.1.D5)
SCALE 3/8" = 1'-0"

COOLING PIPING SECTION VIEWS

NOTES

24009 MP413

REFERENCE DEFINITION	
SHEET COLUMN	SHEET ROW
(#, X#)	

COPYRIGHT AND DISCLAIMER
THIS WORK IS THE SOLE PROPERTY OF I.B. STOREY INC AND IS INTENDED SOLELY FOR THE INFORMATION OF THE CLIENT. ALL RIGHTS RESERVED. THE WORK MAY NOT BE REPRODUCED OR DISTRIBUTED, WHOLE OR IN PART, WITHOUT THE PRIOR WRITTEN PERMISSION OF I.B. STOREY INC.
THIS DOCUMENT MAY NOT BE USED FOR ANY OTHER PROJECTS OR WITHOUT INVOLVEMENT OF I.B. STOREY INC. ANY USE WHICH A THIRD PARTY MAKES OF THE WORK, OR ANY RELIANCE ON OR DECISIONS TO BE MADE BASED ON IT, ARE THE RESPONSIBILITY OF SUCH THIRD PARTIES.

- NOT FOR CONSTRUCTION -
CONFIDENTIAL & PROPRIETARY

VER #	REVISIONS	DATE	BY
2.0	TP2 ADDENDUM #1	11-DEC-24	H.D.
1.0	ISSUED FOR TENDER	21-NOV-24	H.D.

I.B. STOREY
Rink Engineering Experts

CHARLOTTETOWN PE
VAUGHAN ON
REDINGTON SHORES FL
PLANO, TX

WWW.IBSTOREY.COM

STAMP

DRAWING NUMBER 24009 MP413	
DRAWING NAME PLANT ROOM COOLING PIPING LARGE-SCALE VIEW	
CLIENT SPRINGFIELD PARK DISTRICT	
PROJECT SPRINGFIELD-PLANT REPLACEMENT	
DRAWN BY H.DHAMELIYA	CHECKED BY J.RITCHIE
DATE 11-DEC-24	REVISION 2.0
SHEET SIZE C	SHEET NO. 2 OF 2

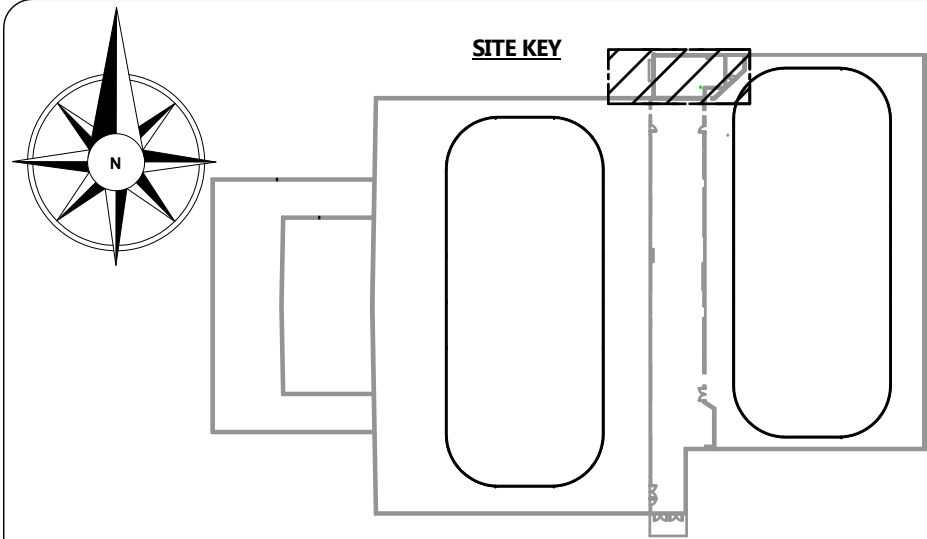

GLYCOL FILLING/TESTING:

- SUPPLY AND INSTALL A NEW CHARGE OF GLYCOL FOR ALL PLANT ROOM EQUIPMENT
- CONTRACTOR TO CARRY ALL PROCUREMENT, TRANSPORTATION, TESTING, AND LABOR REQUIRED TO PROVIDE THE GLYCOL CHARGE
- FLUID: 40% ETHYLENE GLYCOL, INCLUDING ALL REQUIRED ADDITIVES AND INHIBITORS
- AFTER CHARGING OF THE SYSTEM, THE CONTRACTOR IS REQUIRED TO ADJUST THE CONCENTRATION TO THE DESIRED AMOUNT
- TESTING MUST BE COMPLETED DEMONSTRATING THAT THE REQUIRED CONCENTRATION HAS BEEN ACHIEVED. PROVIDE ALL TESTING REPORTS TO THE CONSULTANT
- STANDARD OF ACCEPTANCE: DOW CHEMICAL'S AMBITROL FL40, OR EQUIVALENT

AUTOMATION VALVES:

- INSTALLED BY CONTRACTOR OF THE SCOPE AND SUPPLY BY OTHERS

NOTES

REFERENCE DEFINITION	
SHEET COLUMN	SHEET ROW
SHEET NUMBER	(#, X#)

COPYRIGHT AND DISCLAIMER
 THIS WORK IS THE SOLE PROPERTY OF I.B. STOREY INC AND IS INTENDED SOLELY FOR THE INFORMATION OF THE CLIENT. ALL RIGHTS RESERVED. THE WORK MAY NOT BE REPRODUCED OR DISTRIBUTED, WHOLE OR IN PART, WITHOUT THE PRIOR WRITTEN PERMISSION OF I.B. STOREY INC.
 THIS DOCUMENT MAY NOT BE USED FOR ANY OTHER PROJECTS OR WITHOUT INVOLVEMENT OF I.B. STOREY INC. ANY USE WHICH A THIRD PARTY MAKES OF THE WORK, OR ANY RELIANCE ON OR DECISIONS TO BE MADE BASED ON IT, ARE THE RESPONSIBILITY OF SUCH THIRD PARTIES.

- NOT FOR CONSTRUCTION -
 CONFIDENTIAL & PROPRIETARY

VER #	REVISIONS	DATE	BY
2.0	TP2 ADDENDUM #1	11-DEC-24	H.D.
1.0	ISSUED FOR TENDER	21-NOV-24	H.D.



CHARLOTTETOWN PE
 VAUGHAN ON
 REDINGTON SHORES FL
 PLANO, TX

WWW.IBSTOREY.COM

STAMP

DRAWING NUMBER		24009 MP415
DRAWING NAME		PLANT ROOM WARM PIPING LARGE-SCALE VIEW
CLIENT		SPRINGFIELD PARK DISTRICT
PROJECT		SPRINGFIELD-PLANT REPLACEMENT
DRAWN BY	CHECKED BY	
H.DHAMELIYA	J.RITCHIE	
DATE	REVISION	
11-DEC-24	2.0	
SHEET SIZE	SHEET NO.	
C	1 OF 2	

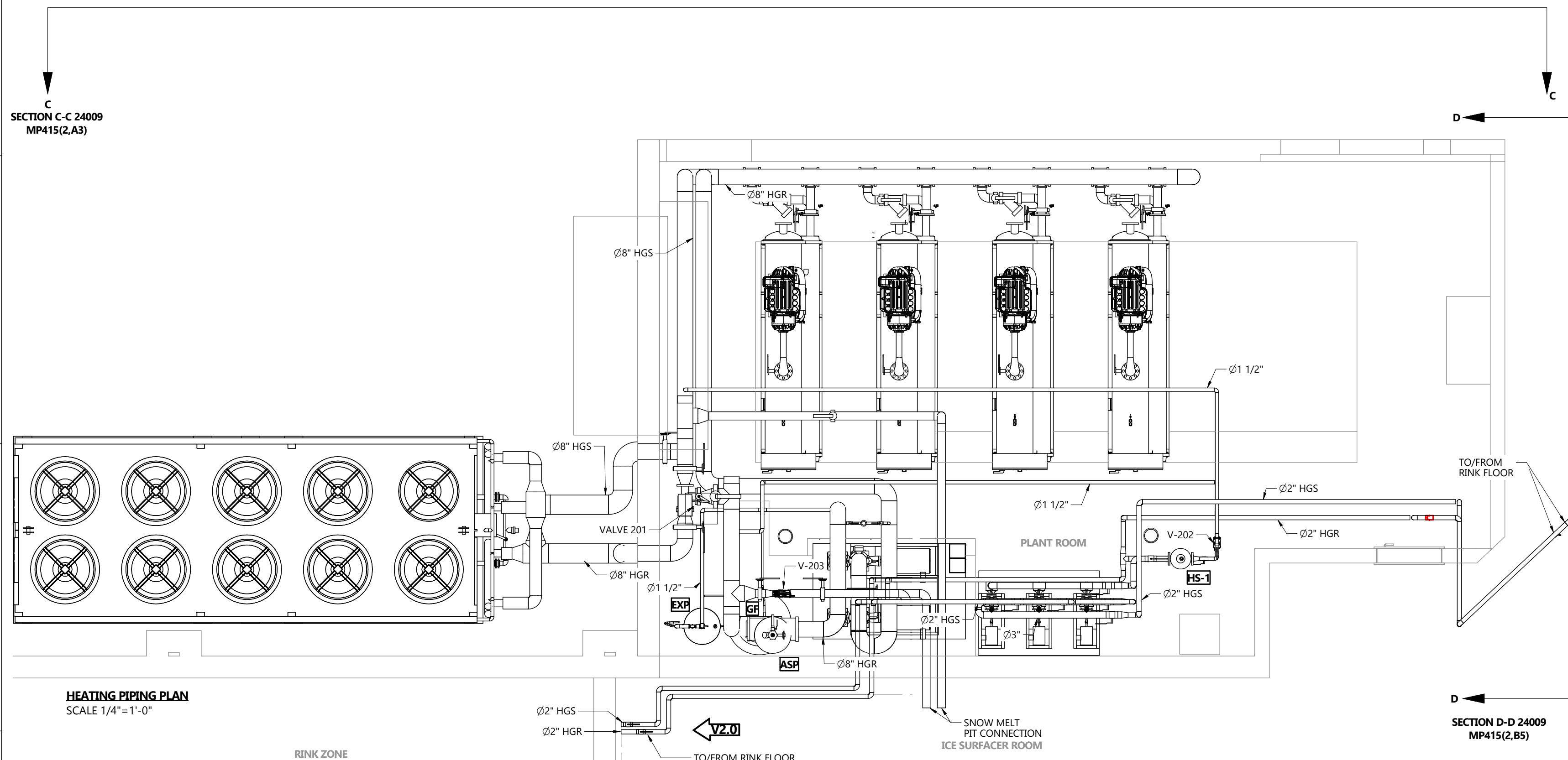

HEATING PIPING PLAN
 SCALE 1/4" = 1'-0"

HEATING PIPING PLAN

24009 MP415

NOTES

REFERENCE DEFINITION	
SHEET COLUMN	SHEET ROW
(#, X#)	

COPYRIGHT AND DISCLAIMER
 THIS WORK IS THE SOLE PROPERTY OF I.B. STOREY INC AND IS INTENDED SOLELY FOR THE INFORMATION OF THE CLIENT. ALL RIGHTS RESERVED. THE WORK MAY NOT BE REPRODUCED OR DISTRIBUTED, WHOLE OR IN PART, WITHOUT THE PRIOR WRITTEN PERMISSION OF I.B. STOREY INC.
 THIS DOCUMENT MAY NOT BE USED FOR ANY OTHER PROJECTS OR WITHOUT INVOLVEMENT OF I.B. STOREY INC. ANY USE WHICH A THIRD PARTY MAKES OF THE WORK, OR ANY RELIANCE ON OR DECISIONS TO BE MADE BASED ON IT, ARE THE RESPONSIBILITY OF SUCH THIRD PARTIES.

- NOT FOR CONSTRUCTION -
 CONFIDENTIAL & PROPRIETARY

VER #	REVISIONS	DATE	BY
2.0	TP2 ADDENDUM #1	11-DEC-24	H.D.
1.0	ISSUED FOR TENDER	21-NOV-24	H.D.



CHARLOTTETOWN PE
 VAUGHAN ON
 REDINGTON SHORES FL
 PLANO, TX

WWW.IBSTOREY.COM

DRAWING NUMBER	
24009 MP415	
DRAWING NAME	
PLANT ROOM WARM PIPING LARGE-SCALE VIEW	
CLIENT	
SPRINGFIELD PARK DISTRICT	
PROJECT	
SPRINGFIELD-PLANT REPLACEMENT	
DRAWN BY	CHECKED BY
H.DHAMELIYA	J.RITCHIE
DATE	REVISION
11-DEC-24	2.0
SHEET SIZE	SHEET NO.
C	2 OF 2

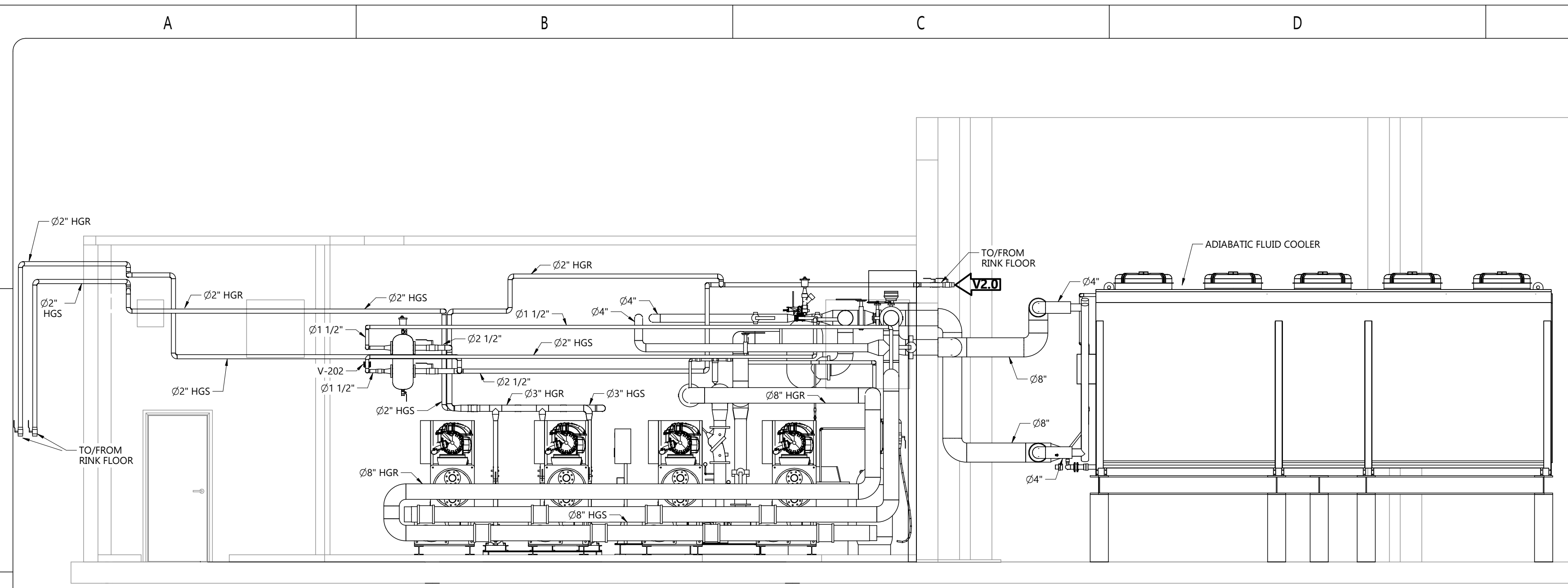

SECTION VIEW C-C 180° (24009 MP415.1.A2)
 SCALE 1/4" = 1'-0"

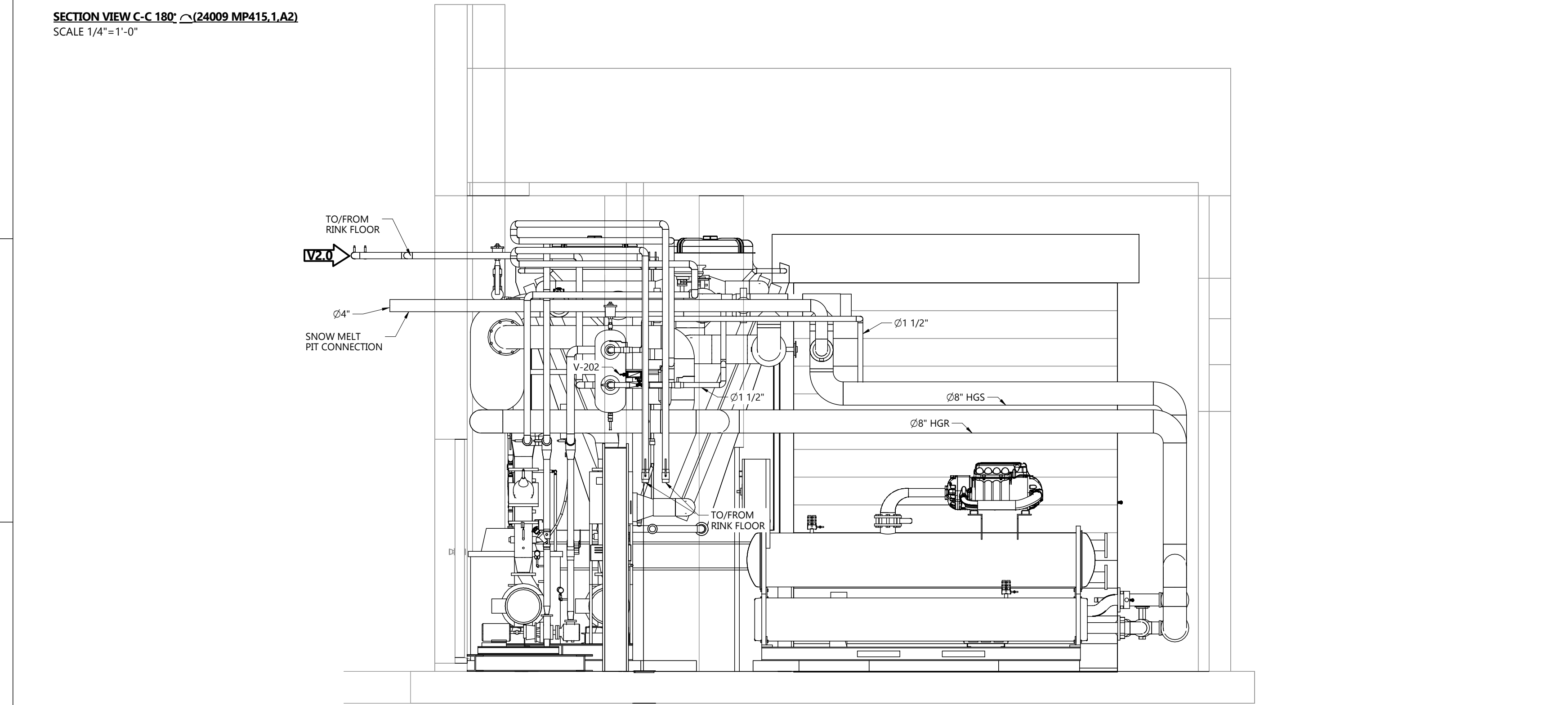

SECTION VIEW D-D 90° (24009 MP415.1.D5)
 SCALE 3/8" = 1'-0"

HEATING PIPING SECTION VIEWS

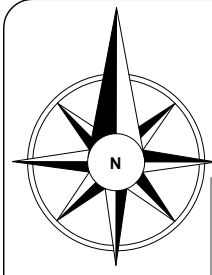

SITE KEY

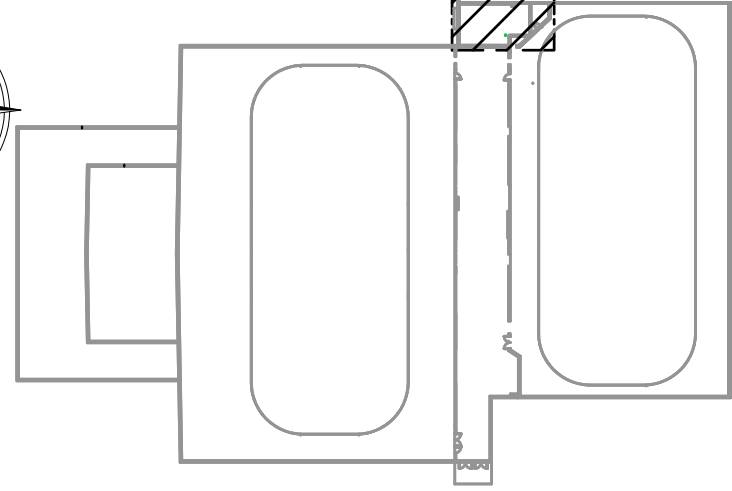

V2.0

V2.0

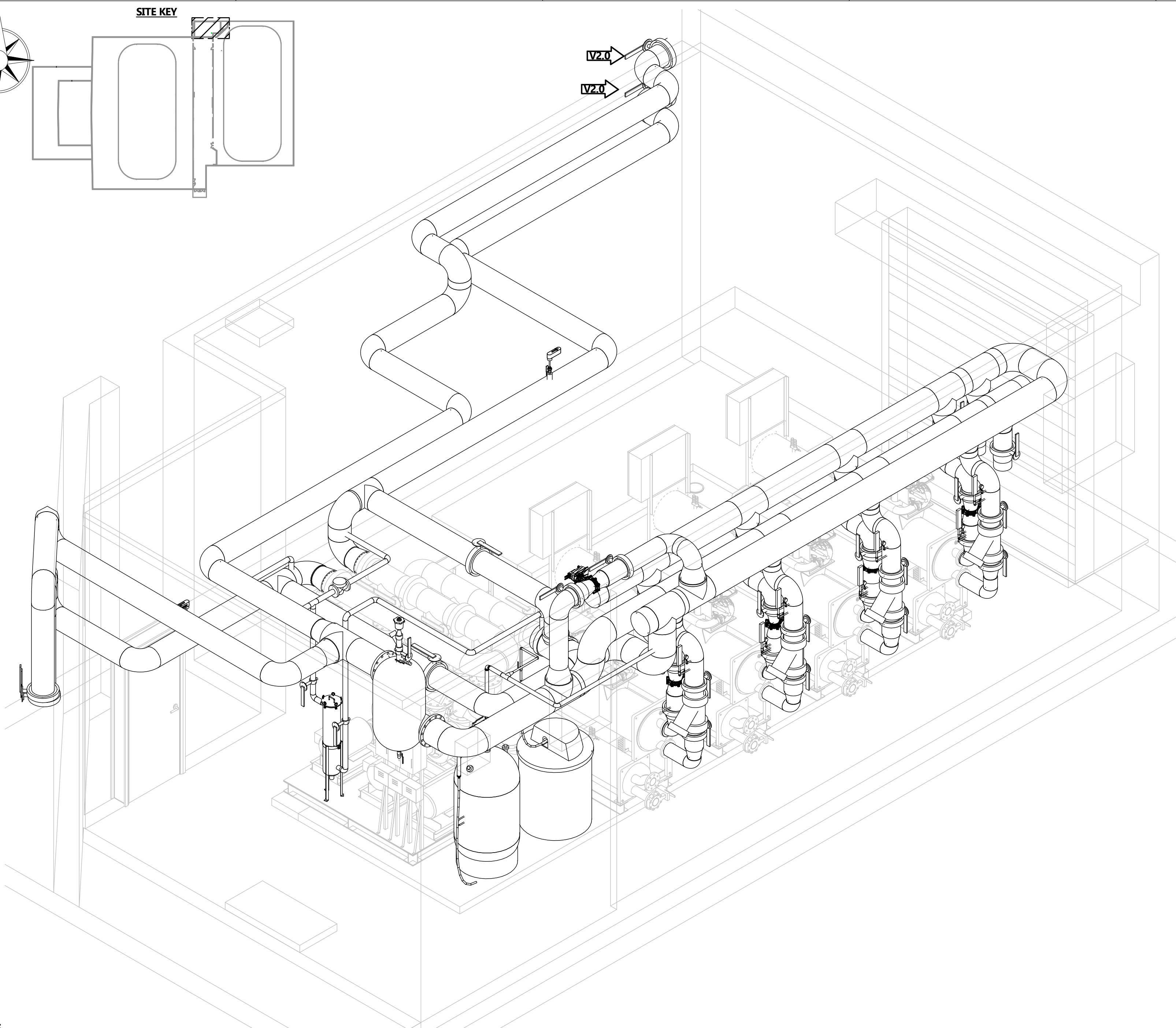

ISOMETRIC VIEW
SCALE 3/8" = 1'-0"

COOLING PIPING ISOMETRIC VIEW

NOTES:

- AFC HIDDEN FOR CLARITY.
- ALL EXHAUST FANS AND INTAKE LOUVERS ARE HIDDEN FOR CLARITY.
- EQUIPMENTS NOT ASSOCIATED WITH COOLING PIPING HIDDEN FOR CLARITY.

NOTES

---	NEW
---	EXISTING

REFERENCE DEFINITION	
SHEET COLUMN	SHEET ROW
SHEET NUMBER	(#, X#)

COPYRIGHT AND DISCLAIMER
THIS WORK IS THE SOLE PROPERTY OF I.B. STOREY INC AND IS INTENDED SOLELY FOR THE INFORMATION OF THE CLIENT. ALL RIGHTS RESERVED. THE WORK MAY NOT BE REPRODUCED OR DISTRIBUTED, WHOLE OR IN PART, WITHOUT THE PRIOR WRITTEN PERMISSION OF I.B. STOREY INC.
THIS DOCUMENT MAY NOT BE USED FOR ANY OTHER PROJECTS OR WITHOUT INVOLVEMENT OF I.B. STOREY INC. ANY USE WHICH A THIRD PARTY MAKES OF THE WORK, OR ANY RELIANCE ON OR DECISIONS TO BE MADE BASED ON IT, ARE THE RESPONSIBILITY OF SUCH THIRD PARTIES.

- NOT FOR CONSTRUCTION -
CONFIDENTIAL & PROPRIETARY

2.0	TP2 ADDENDUM #1	11-DEC-24	H.D.
1.0	ISSUED FOR TENDER	21-NOV-24	R.T.
VER #	REVISIONS	DATE	BY



CHARLOTTETOWN PE
VAUGHAN ON
REDINGTON SHORES FL
PLANO, TX

WWW.IBSTOREY.COM

STAMP

DRAWING NUMBER 24009 MP911	
DRAWING NAME COOLING PIPING ISOMETRIC VIEW	
CLIENT SPRINGFIELD PARK DISTRICT	
PROJECT SPRINGFIELD-PLANT REPLACEMENT	
DRAWN BY H.DHAMELIYA	CHECKED BY J.RITCHIE
DATE 11-DEC-24	REVISION 2.0
SHEET SIZE C	SHEET NO. 1 OF 1

24009 MP911

1

2

3

4

5

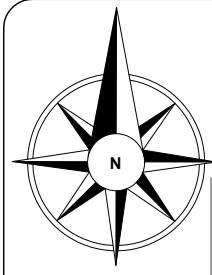

SITE KEY

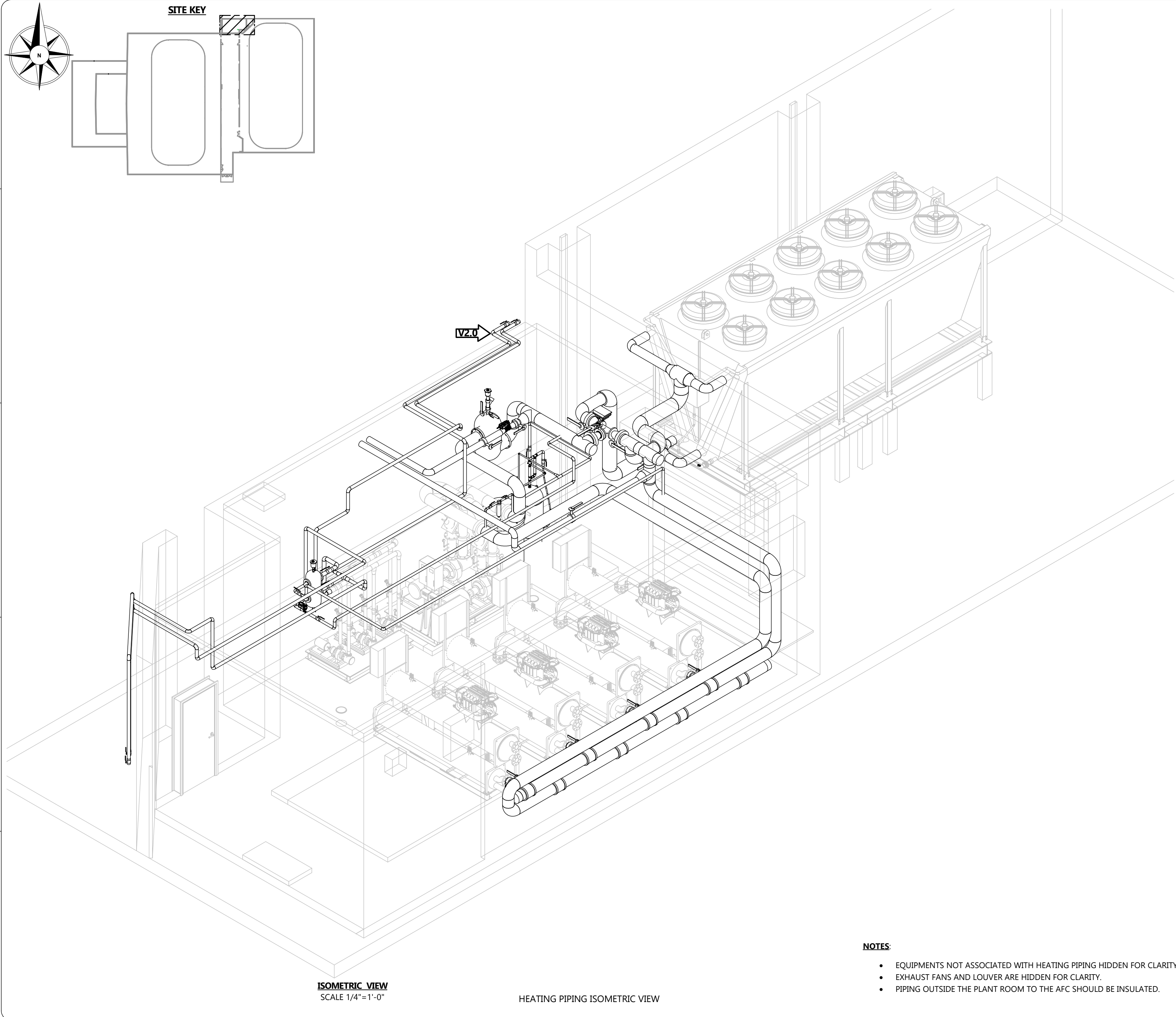
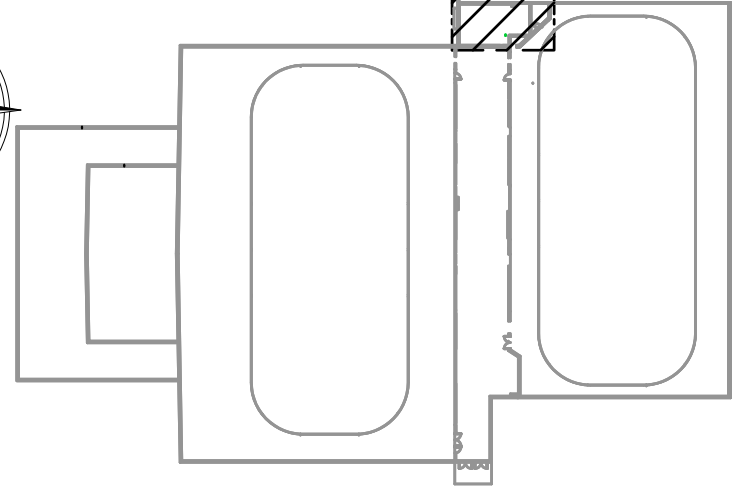

ISOMETRIC VIEW
SCALE 1/4"=1'-0"

HEATING PIPING ISOMETRIC VIEW

NOTES:

- EQUIPMENTS NOT ASSOCIATED WITH HEATING PIPING HIDDEN FOR CLARITY.
- EXHAUST FANS AND LOUVER ARE HIDDEN FOR CLARITY.
- PIPING OUTSIDE THE PLANT ROOM TO THE AFC SHOULD BE INSULATED.

NOTES

REFERENCE DEFINITION	
SHEET COLUMN	SHEET ROW
SHEET NUMBER	(#, X#)

COPYRIGHT AND DISCLAIMER
 THIS WORK IS THE SOLE PROPERTY OF I.B. STOREY INC AND IS INTENDED SOLELY FOR THE INFORMATION OF THE CLIENT. ALL RIGHTS RESERVED. THE WORK MAY NOT BE REPRODUCED OR DISTRIBUTED, WHOLE OR IN PART, WITHOUT THE PRIOR WRITTEN PERMISSION OF I.B. STOREY INC.
 THIS DOCUMENT MAY NOT BE USED FOR ANY OTHER PROJECTS OR WITHOUT INVOLVEMENT OF I.B. STOREY INC. ANY USE WHICH A THIRD PARTY MAKES OF THE WORK, OR ANY RELIANCE ON OR DECISIONS TO BE MADE BASED ON IT, ARE THE RESPONSIBILITY OF SUCH THIRD PARTIES.

- NOT FOR CONSTRUCTION -
 CONFIDENTIAL & PROPRIETARY

VER #	REVISIONS	DATE	BY
2.0	TP2 ADDENDUM #1	11-DEC-24	H.D.
1.0	ISSUED FOR TENDER	21-NOV-24	R.T.



CHARLOTTETOWN PE
 VAUGHAN ON
 REDINGTON SHORES FL
 PLANO, TX

WWW.IBSTOREY.COM

STAMP

DRAWING NUMBER 24009 MP913	
DRAWING NAME HEATING PIPING ISOMETRIC VIEW	
CLIENT SPRINGFIELD PARK DISTRICT	
PROJECT SPRINGFIELD-PLANT REPLACEMENT	
DRAWN BY H.DHAMELIYA	CHECKED BY J.RITCHIE
DATE 11-DEC-24	REVISION 2.0
SHEET SIZE C	SHEET NO. 1 OF 1

24009 MP913

1

2

3

4

5